



# Surgical Instruments













## Surgical Instrument



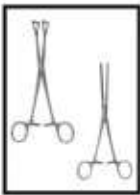

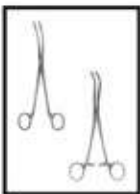
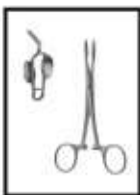
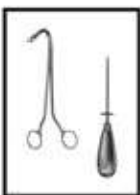
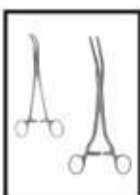



Whatsapp  
**+923279393212**

**EMAIL : [Info@huscoind.com](mailto:Info@huscoind.com)**

# Table Of Contents

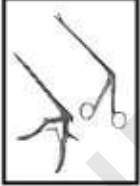
|   |                         |   |   |                          |   |
|---|-------------------------|---|---|--------------------------|---|
| Diagnostic, Anaesthesia and other instruments                 | Page<br>Seite<br>1 - 10 |    | Probes, Pocket Instruments sets                             | Page<br>Seite<br>66 - 68 |    |
| Scalpels, knives and Scalpel Handles                          | 11 - 14                 |    | Wound Retractors  | 69 - 80                  |    |
| Scissors  | 15 - 31                 |    | Self-Retaining Retractors, Abdominal Retractors             | 81 - 85                  |    |
| Dissecting-and Tissue Forceps                                 | 32 - 42                 |   | Abdominal Surgery Intestinal-and Rectal Instruments         | 86 - 93                  |   |
| Sponge, Dressing and Tissue Grasping Forceps Towel Clamps     | 43 - 48                 |  | Gall Bladder-, Liver-and Spleen Instruments                 | 94 - 96                  |  |
| Vessel Clips, Bulldog Clamps Haemostatic Forceps              | 49 - 57                 |  | Genito-Urinary Instruments and Trocars                      | 97 - 100                 |  |
| Ligature, Hysterectomy and Compression Forceps Vaginal Clamps | 58 - 60                 |  | Vaginal Specula and Uterine Dilators                        | 101 - 106                |  |
| Needle Holders, Suture Instruments                            | 61 - 65                 |  | Uterine Probes, Uterine Dressing-, Polypus-and Ovum Forceps | 107 - 109                |  |

# Table Of Contents

|  | Page<br>Seite |   | Page<br>Seite       |           |
|--|---------------|---|---------------------|-----------|
| Biopsy Instruments<br>and Curettes                                   | 110 - 116     |    | Suction Instruments | 158 - 166 |
| Obstetrics and Tracheotomy   | 117 - 119     |    |                     |           |
| Cardiovascular-and<br>Thoracic Surgery                               | 120 - 128     |    |                     |           |
| Bone Punches, Rongeurs   | 129 - 134     |   |                     |           |
| Elevators, Bone Levers,<br>Raspatories, Bone Files,<br>Bone Curettes | 135 - 139     |  |                     |           |
| Mallets, Chisels<br>and Gouges                                       | 140 - 141     |  |                     |           |
| Bone Holding Forceps,<br>Bone Rongeurs,<br>Bone Cutting Forceps      | 142 - 146     |  |                     |           |
| Plaster Instruments  | 147 - 157     |  |                     |           |

## Percussion Hammers and Aesthesiometers



**01-101**  
TROEMNER  
Size: 245 mm



**01-102**  
DEJERINE  
Size: 200 mm



**01-103**  
DEJERINE  
with needle  
Size: 210 mm



**01-104**  
TAYLOR  
Size: 195 mm

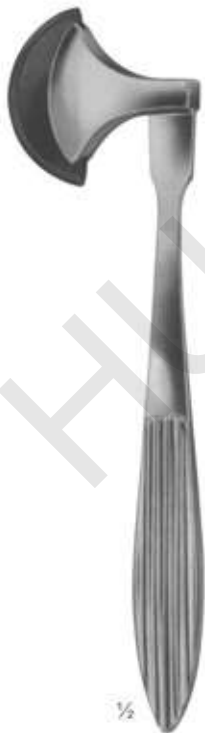

**01-105**  
BERLINER  
Size: 200 mm

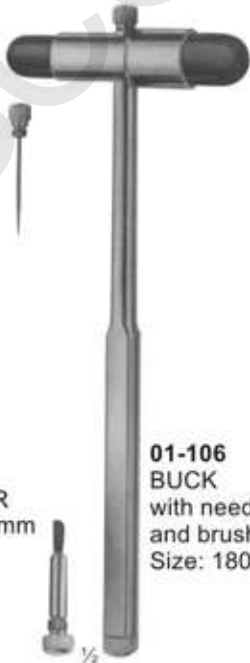

**01-106**  
BUCK  
with needle  
and brush  
Size: 180 mm



**01-107**  
RABINER  
with needle  
and brush  
Size: 255 mm



**01-108**  
ALY  
Size: 190 mm



**01-109**  
WARTENBERG  
Pinwheel for  
neurological  
examination  
Size: 185 mm

## Stethoscopes



**01-110**  
PINARD (Aluminum)  
Size: 155 mm

½



**01-111**  
wooden  
Size: 145 mm

½



**01-112**  
BOWLES  
Stethoscope  
with diaphragm

¼



**01-113**  
ANESTOPHON

½



**01-114**  
FORD-BOWLES  
Dual chest piece  
with two outlets

¼



**01-115**  
BOWLES

¼

## Head Mirrors and Head Bands



**01-116**  
ZIEGLER Ø 90mm  
head mirror only  
with rubber coating

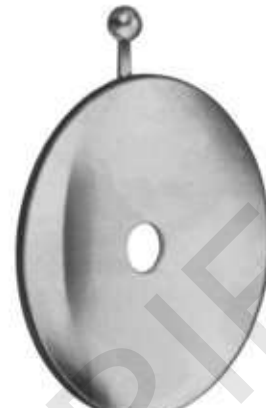

**01-117**  
ZIEGLER Ø 90mm  
head mirror only  
with metal coating



**01-118**  
ZIEGLER  
head band of plastic black

**01-119**  
ZIEGLER  
head band of plastic white



**01-120**  
MURPHY  
head band of celluloid, white



**01-121**  
head band of plastic,  
white, soft pattern



**01-122**  
head mirror with black  
plastic head band.

# Tongue Depressors

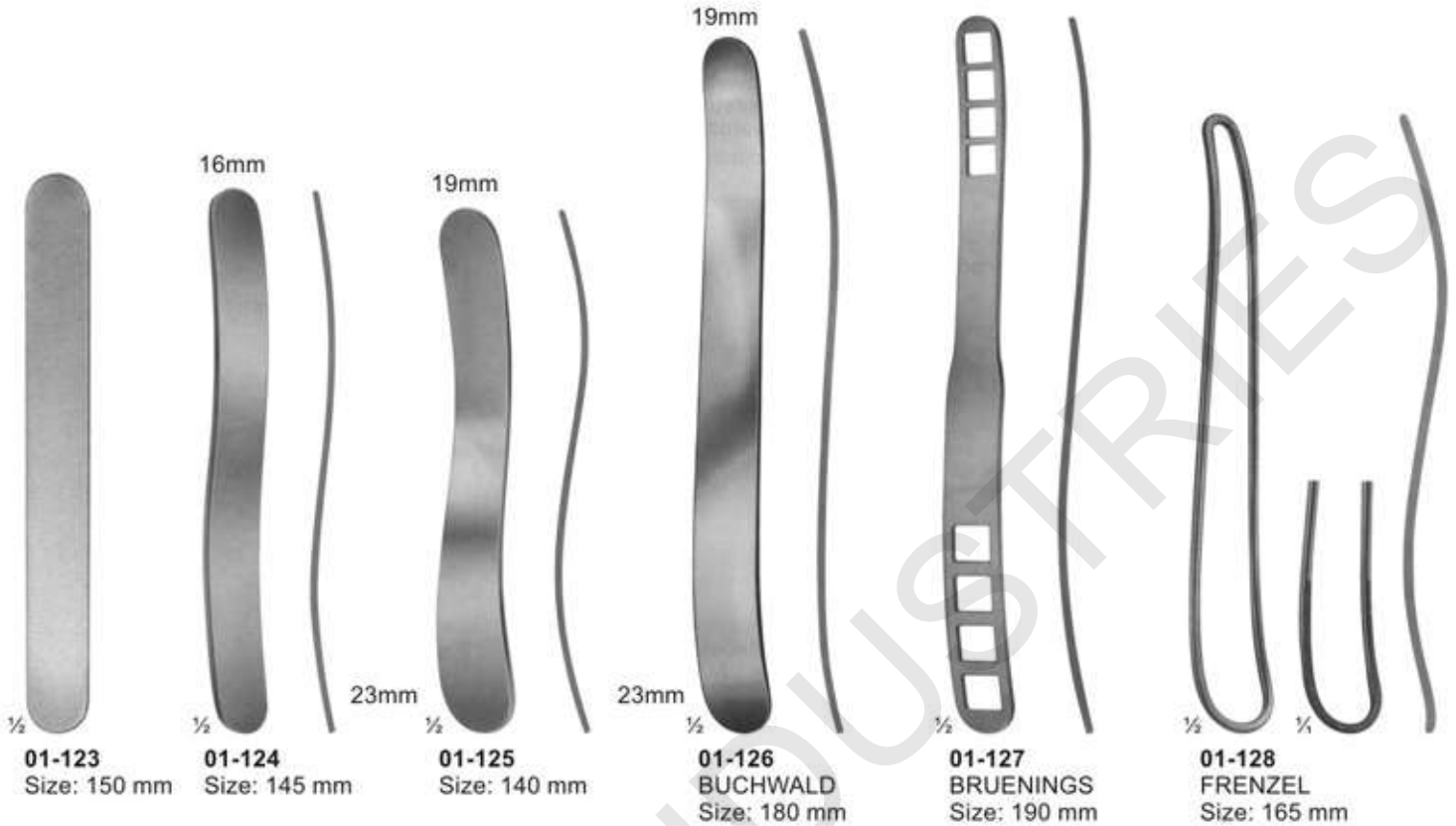

## Instruments for Anaesthesia and Tongue Forceps



1/2  
**01-134**  
**SCHIMMELBUSCH**  
Ether mask



1/2  
**01-135**  
**HEISTER**  
Mouth gag  
Size: 130 mm



1/2  
**01-136**  
**FERGUSSON-ACKLAND**  
Mouth gag  
Size: 145 mm



1/2  
**01-137**  
**DENHARDT**  
Mouth gag with silicon  
inserts, interchangeable  
Size: 125 mm



1/2  
**01-138**  
**ROSER KOENIG**  
Mouth gag  
Size: 160 mm, 185 mm

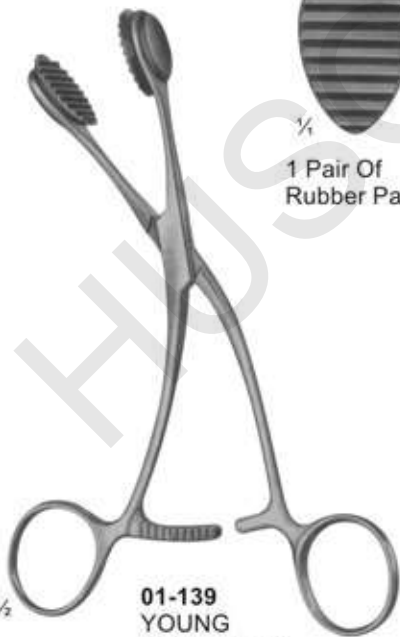

1/2  
**01-139**  
**YOUNG**  
Size: 165 mm



1/4  
1 Pair Of  
Rubber Pads

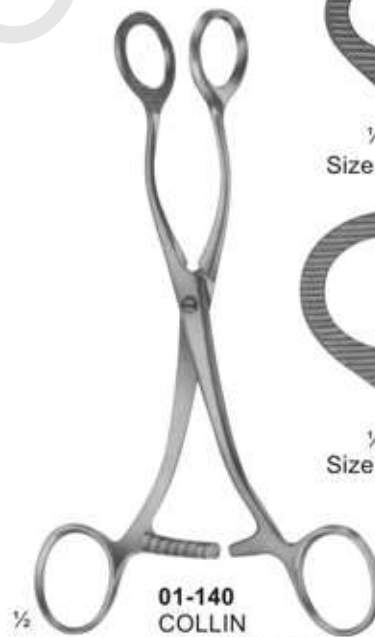

1/2  
**01-140**  
**COLLIN**  
Size: 160 mm,  
170 mm



1/4  
Size: 160 mm



1/4  
Size: 170 mm



1/2  
**01-141**  
**HEYWOOD-SMITH**  
modif. Size: 215 mm



# Blood Lancets and Laryngeal Mirrors



**01-142**  
FRANCKE  
Automatic blood lancet

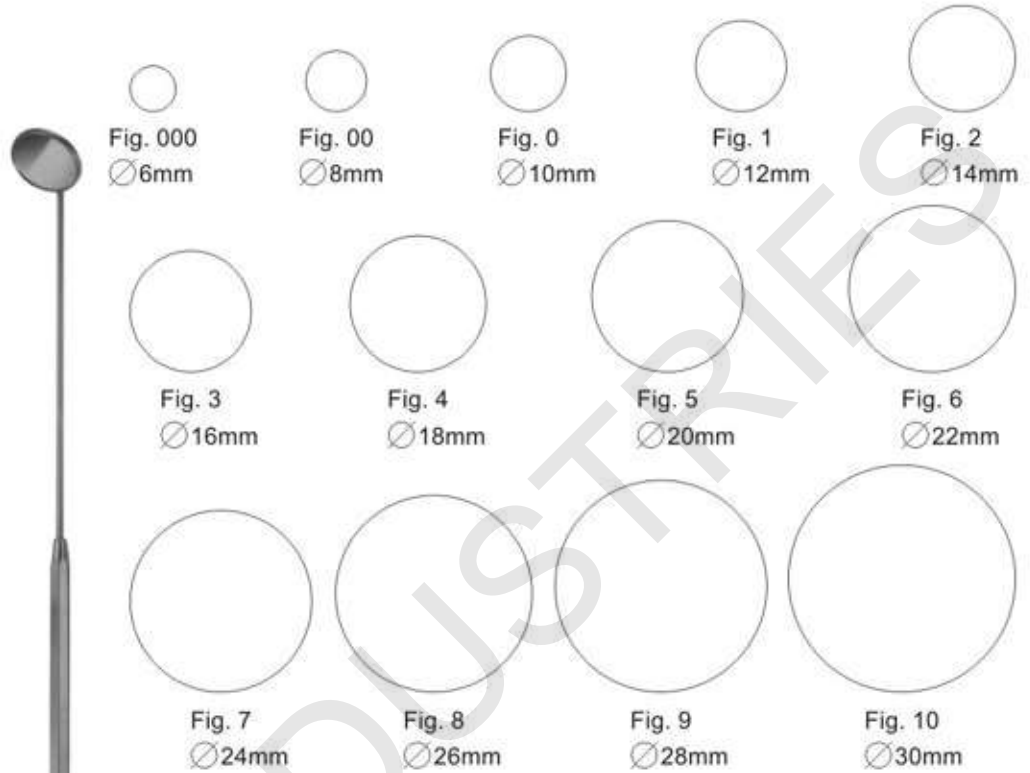

**01-143**  
Laryngeal mirrors with  
hexagonal handle  
Size: 180 mm



**01-148**  
Spare mirrors only  
Size: 12 mm



**01-149**  
Spare mirrors only  
Size: 14 mm



**01-144**  
KOLLE  
Microscopic Needle  
Holder with plastic  
handle.  
Size: 240 mm



**01-145**  
Mirror handle  
Size: 110 mm



**01-146**  
Mirror handle  
Size: 105 mm



**01-147**  
MICHEL  
Rhinoscopic mirrors with  
interchangeable mirror inserts  
Size: 250 mm

## Laryngoscope and Diagnostic Sets



**01-150**  
Infants  
Size: 150 mm



**01-151**  
Children  
Size: 200 mm



**01-152**  
Adults  
Size: 250 mm

1/2

**01-150 - 152**  
MAGILL



**01-154**



**01-153**  
Medium battery handle  
only, 25 mm diam.



**01-153-A**  
Spare bulb  
2.7 volt, for  
otoscopes



**01-153-B**  
Spare bulb  
2.6 volt, for  
ophthalmoscopes



**01-155**



**01-156**  
Otoscope set, consists of  
battery handle without batteries,  
3 ear specula, 1 bulb in valvet lined case



**01-157**  
Diagnostic set, otoscope with three specula,  
nasal speculam, lamp holder, two laryngeal  
mirrors, tongue blade holder

# Laryngoscopes



**01-158**  
**MILLER**  
 Laryngoscope set, consists of battery handle ( without battery )  
 with four miller laryngoscope blades

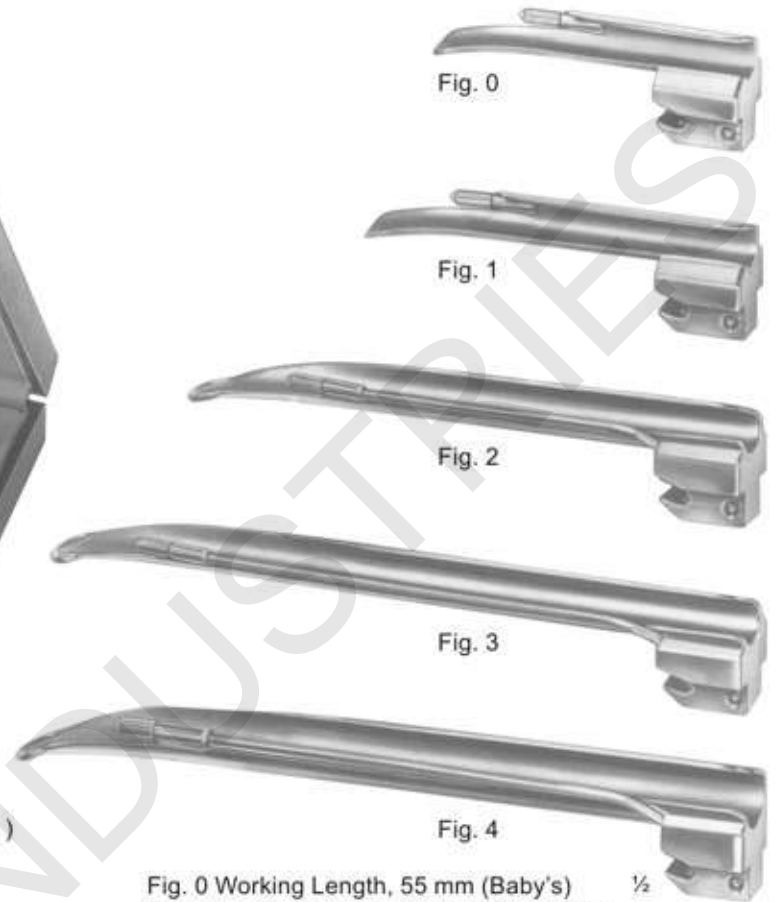

Fig. 0 Working Length, 55 mm (Baby's)  
 Fig. 1 Working Length, 80 mm (Children's)  
 Fig. 2 Working Length, 130 mm (Adolescent's)  
 Fig. 3 Working Length, 170 mm (Women's)  
 Fig. 4 Working Length, 180 mm (Men's)



**01-159**  
**GUEDEL-NEGUS**  
 Laryngoscope set, consists of battery handle ( without battery )  
 with four miller laryngoscope blades

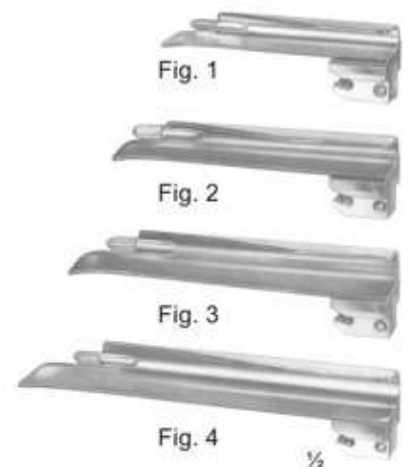

Fig. 1 Working Length, 70 mm (Children's)  
 Fig. 2 Working Length, 90 mm (Adolescent's)  
 Fig. 3 Working Length, 110 mm (Women's)  
 Fig. 4 Working Length, 135 mm (Men's)

# Laryngoscopes



**01-160**  
**McINTOSH**  
 Laryngoscope Set, Consists Of Battery Handle ( Without Battery )  
 With Three McIntosh Blades, Fig. 1, Fig. 2, Fig. 3

**01-161**  
**McINTOSH**  
 Laryngoscope Set, Consists Of Battery Handle ( Without Battery )  
 With Five McIntosh Blades, Fig. 0, Fig. 1, Fig. 2, Fig. 3, Fig. 4



Fig. 0



Fig. 1



Fig. 2

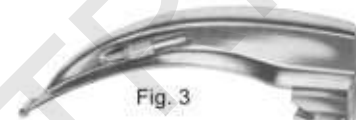

Fig. 3



Fig. 4

01-161 A Fig. 0 Working Length, 55 mm (Baby's)  
 01-161 B Fig. 1 Working Length, 75 mm (Children's)  
 01-161 C Fig. 2 Working Length, 90 mm (Adolescent's)  
 01-161 D Fig. 3 Working Length, 110 mm (Women's)  
 01-161 E Fig. 4 Working Length, 135 mm (Men's)

**01-162**  
**FOREGGER**  
 Laryngoscope Set, Consists Of Battery Handle ( Without Battery )  
 With Three Foregger Blades, Fig. 1, Fig. 2, Fig. 3.



**01-163**  
**FOREGGER**  
 Laryngoscope Set, Consists Of Battery Handle ( Without Battery )  
 With Four Foregger Blades, Fig. 1, Fig. 2, Fig. 3, Fig. 4.



Fig. 1



Fig. 2



Fig. 3



Fig. 4

01-162 A Fig. 1 Working Length, 70 mm (Children's)  
 01-162 B Fig. 2 Working Length, 90 mm (Adolescent's)  
 01-162 C Fig. 3 Working Length, 110 mm (Women's)  
 01-162 D Fig. 4 Working Length, 135 mm (Men's)



**01-164**  
 Fiber Optic  
 Battery Handle  
 30mm diam.



**01-165**  
 Fiber Optic  
 Battery Handle  
 18mm diam.



**01-166**  
 Replacement Lamp  
 ( Krypton ) 2.5 V



**01-167**  
 Replacement Lamp  
 ( Halogen ) 2.5 V

## Examination & Measuring Instruments



**01-168**  
Caliper Of Aluminium  
Graduated in mm & inches  
up to 180mm  
Measuring Range up to 139mm



**01-169**  
VERNIER  
Universal Caliper Of Steel  
Graduated in mm & inches  
up to 180mm  
Measuring Range up to 120mm  
with Vernier in 1/10mm & 1/16"



**01-170**  
CARROLL  
Size: 145 mm  
Finger Goniometer



**01-171**  
TOWNLEY  
Graduated in  
mm & inches  
Size: 115 mm



**01-172**  
COLLIN  
Druck Pressure 72 kg  
Size: 125 mm



**01-173**  
BERTILLON  
Caliper For Measuring The Head  
Size: 320 mm



**01-174**  
CASTROVIEJO  
Caliper  
Size: 75mm



**01-175**  
MOLTGEN  
Goniometer



**01-176**  
Size: 150 mm



**01-177**  
Size: 500 mm



# Dissecting Knives



1/2  
**02-101 - 110**  
 Fig. 1 - 10



**02-101**  
 Fig. 1  
 30 mm



**02-102**  
 Fig. 2  
 36 mm



**02-103**  
 Fig. 3  
 40 mm



**02-104**  
 Fig. 4  
 45 mm



**02-105**  
 Fig. 5  
 50 mm



1/2  
**02-106**  
 Fig. 6  
 27 mm



**02-107**  
 Fig. 7  
 35 mm



**02-108**  
 Fig. 8  
 40 mm



**02-109**  
 Fig. 9  
 47 mm



**02-110**  
 Fig. 10  
 50 mm

## Amputating Knives, Cartilage Knives and Autopsy Knives



LISTON  
**02-111**  
 Size: 130 mm  
**02-112**  
 Size: 160 mm  
**02-113**  
 Size: 190 mm  
**02-114**  
 Size: 200 mm

**02-115**  
 CATLIN  
 Size: 160 mm  
 Blade length  
 Amputating  
 Knives

**02-116**  
 LANGENBECK  
 Size: 120 mm  
 Blade length  
 Flap Knives

**02-117**  
 Size: 110 mm  
 Blade length  
 Interosseous  
 Knives

**02-118**  
 Size: 55 mm  
 Blade length  
 with raspatory,  
 Wooden handle

**02-119**  
 Size: 70 mm  
 Blade length  
 Wooden handle

**02-120**  
 Size: 80 mm  
 Blade length  
 Metal handle

**02-121**  
 Size: 195 mm  
 Blade length  
 Metal handle

Blade length  
 Amputating Knives

# Cone Knives, Myomatome, Trigeminal and Tonsil Knives



1/4

**02-122**  
AYRE  
Size: 235 mm  
Cone Knife

1/4

**02-123**  
Size: 230 mm  
Cone Knife

1/4

**02-124**  
SEGOND  
Size: 270 mm  
Myomatome

1/4

1/4

**02-125**  
OLIVECRONA  
Size: 205 mm  
Trigeminal  
Knife

1/4

**02-126**  
Size: 230 mm  
Trigeminal  
Knife

1/4

**02-127**  
FOWLER  
Size: 200 mm  
Tonsil Knife

1/4

**02-128**  
ABRAHAM  
Size: 215 mm  
Tonsil Knife

1/4

**02-129**  
BRUNINGS  
Size: 215 mm  
Tonsil Knife



## Scalpel Handles



02-130  
STANDARD  
No. 3  
Solid  
12 cm

02-131  
No. 3  
Solid  
12 cm

02-132  
No. 3  
Solid  
12 cm

02-133  
No. 3 L  
Straight  
Solid  
21.5 cm

02-134  
No. 3 L  
Angled  
Solid  
21 cm

02-135  
No. 7  
Solid  
16 cm

02-136  
No. 7 K  
Solid  
12.5 cm

02-137  
Hollow-Round  
15.5 cm

02-138  
No. 3  
Straight  
Solid,  
Round  
14.5 cm

02-139  
No. 3  
Angled  
Solid,  
Round  
14 cm

# Micro Scissors (Spring Type) with Flat Handles

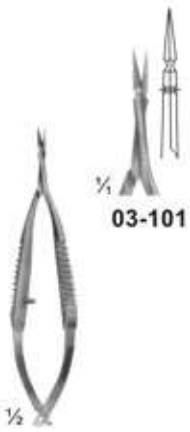

**03-101 - 103**  
VANNAS  
Size: 85 mm



**03-101**



**03-102**



**03-103**



**03-104 - 105**  
CASTROVIEJO  
Size: 95 mm



**03-104**



**03-105**



**03-106**  
NOYES  
Size: 125 mm

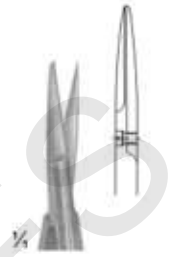

**03-106**

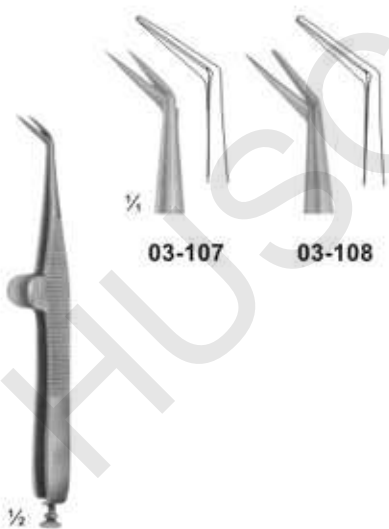

**03-107 - 108**  
WECKER  
Eye scissor  
Size: 110 mm



**03-107**



**03-108**



**03-109**  
CASTROVIEJO  
Eye scissor  
Size: 115 mm



**03-109**

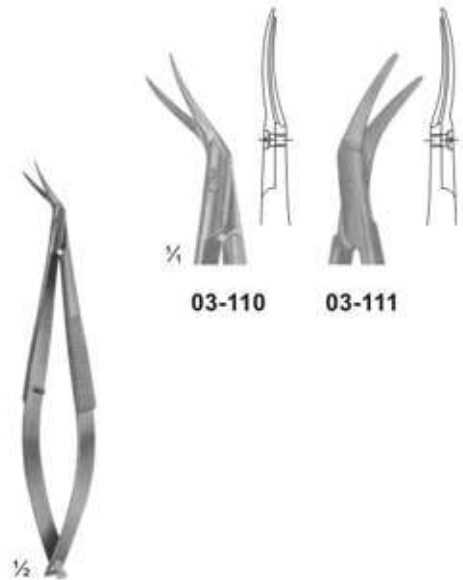

**03-110 - 111**  
CASTROVIEJO  
Eye scissor  
Size: 110 mm



**03-110**



**03-111**

## Micro Scissors (Spring Type) with Flat Handles

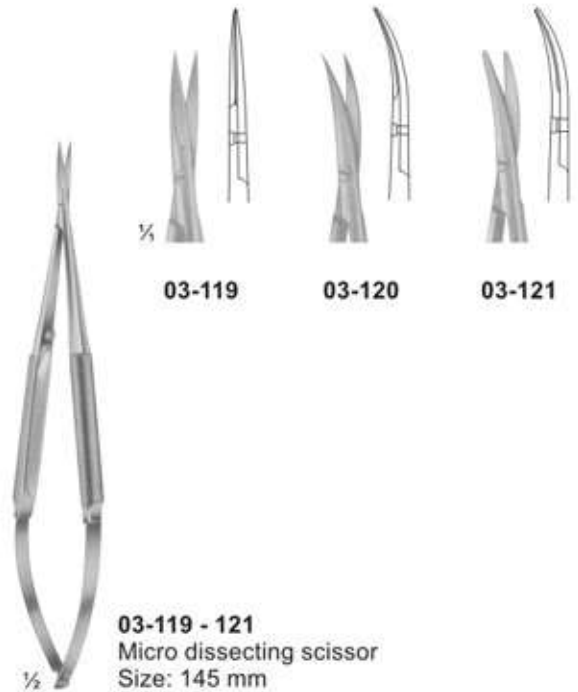
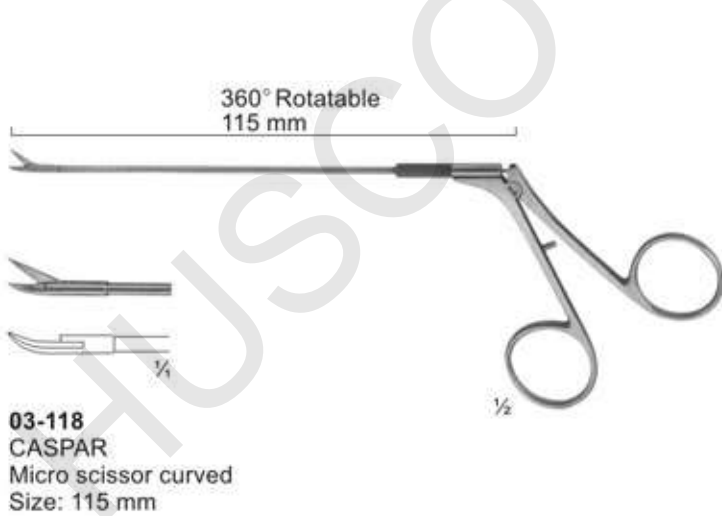
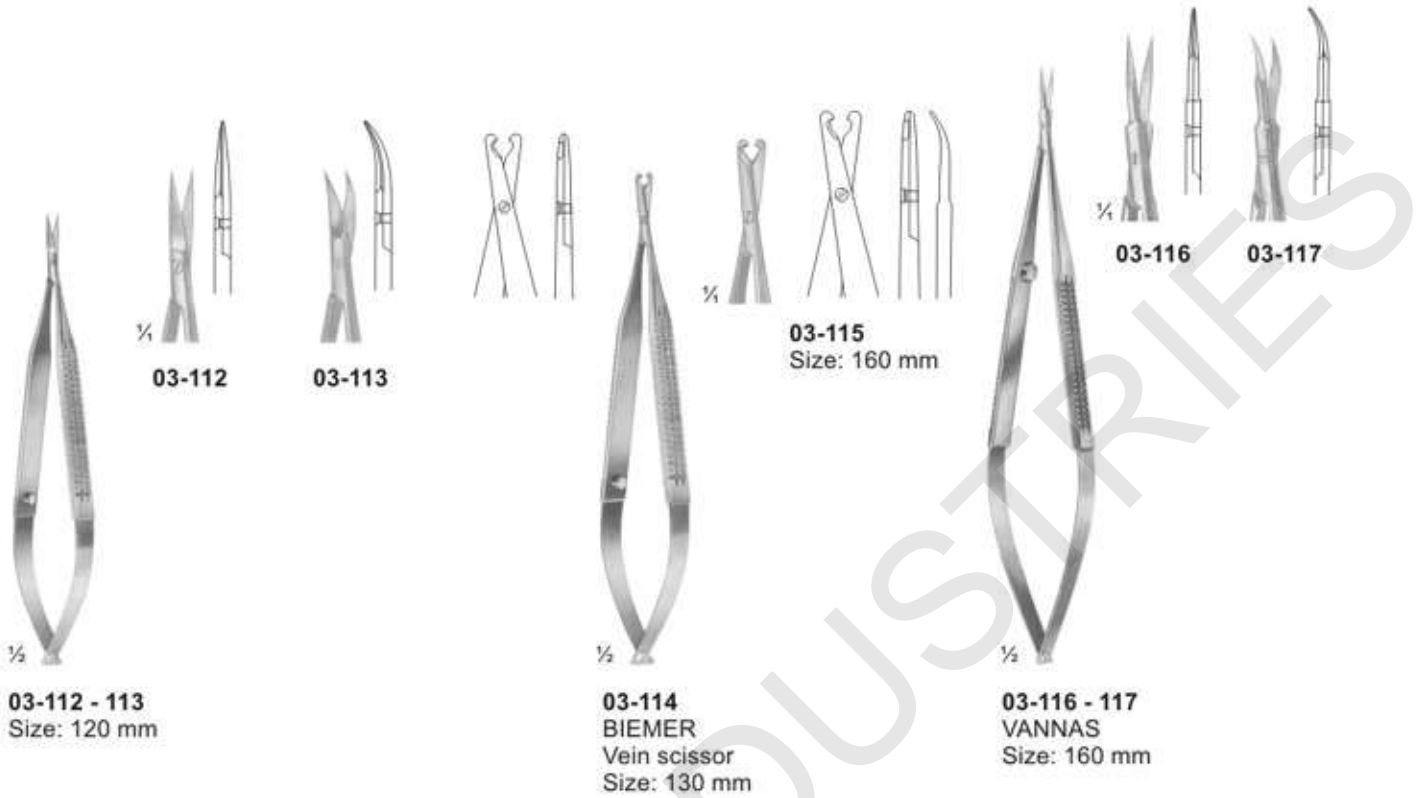

**Micro Scissors (Spring Type) bayonet-Shaped**



03-122  
YASARGIL  
Size: 245 mm



03-123 - 124  
laterally angled  
Size: 200 mm



03-125  
laterally angled  
Size: 190 mm

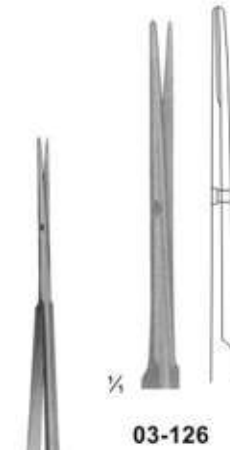

03-126



03-127



03-126 - 127  
YASARGIL  
Size: 225 mm

## Delicate Scissors

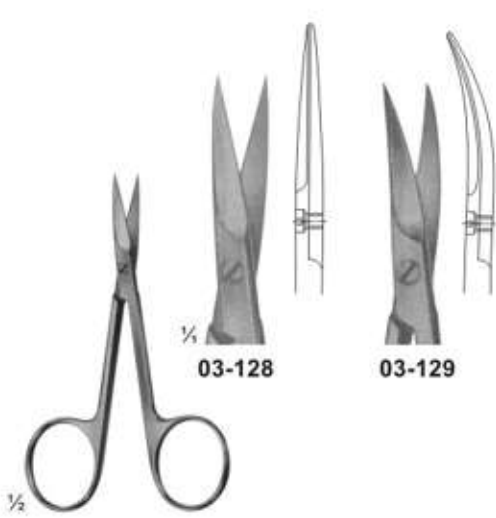

03-128

03-129

03-128 - 129  
Size: 90 mm



03-130

03-131

03-130 - 131  
Size: 95 mm



03-132

03-133

03-132 - 133  
Size: 105 mm



03-134

03-135

03-134 - 135  
Size: 120 mm



03-136

03-137

03-136 - 137  
Size: 115 mm

## Delicate Scissors



**03-138 - 140**  
Size: 120 mm



**03-138**



**03-139**



**03-140**



**03-141 - 144**  
Size: 130 mm



**03-141**



**03-142**



**03-143**



**03-144**



# Surgical Scissors

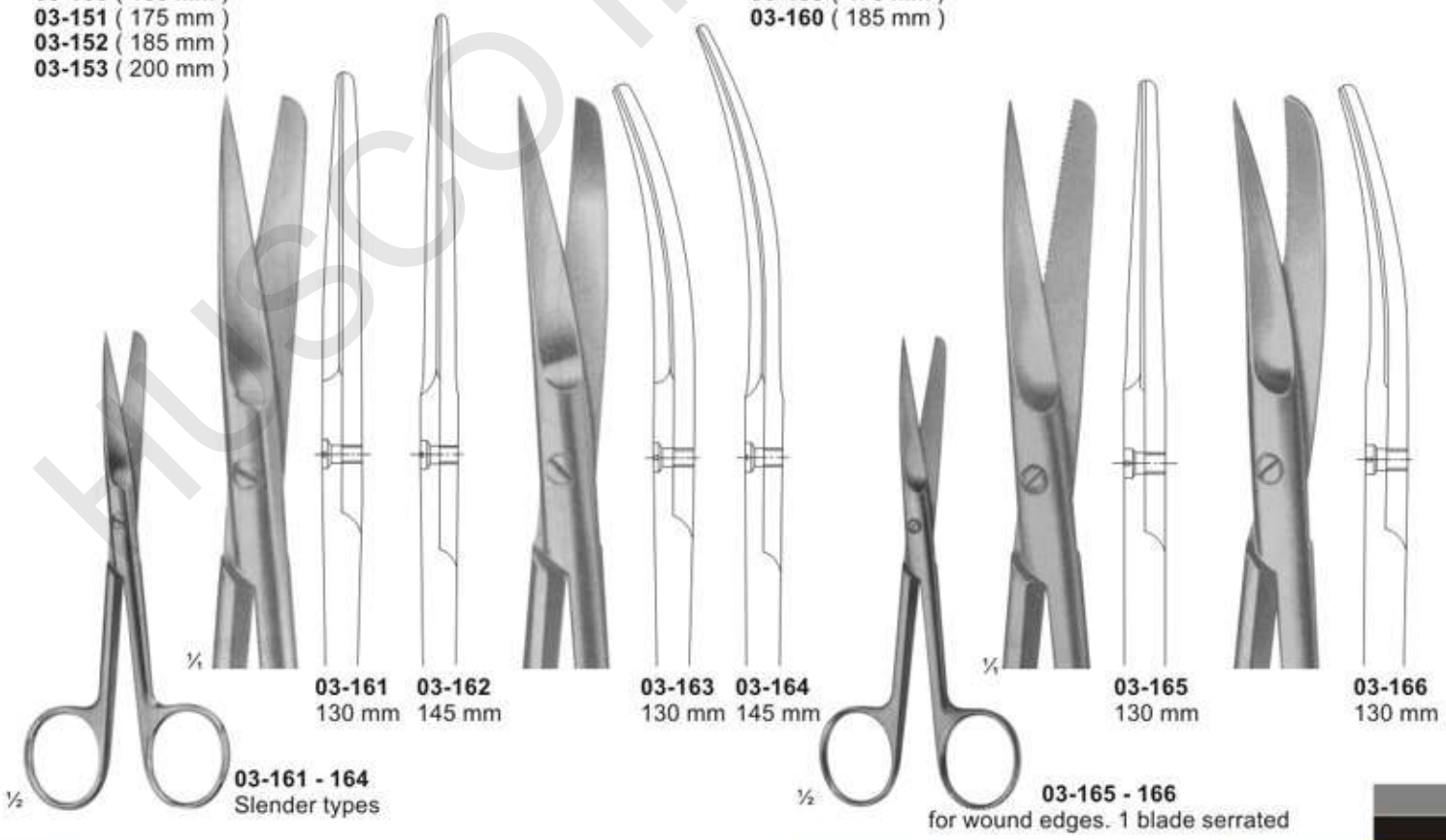
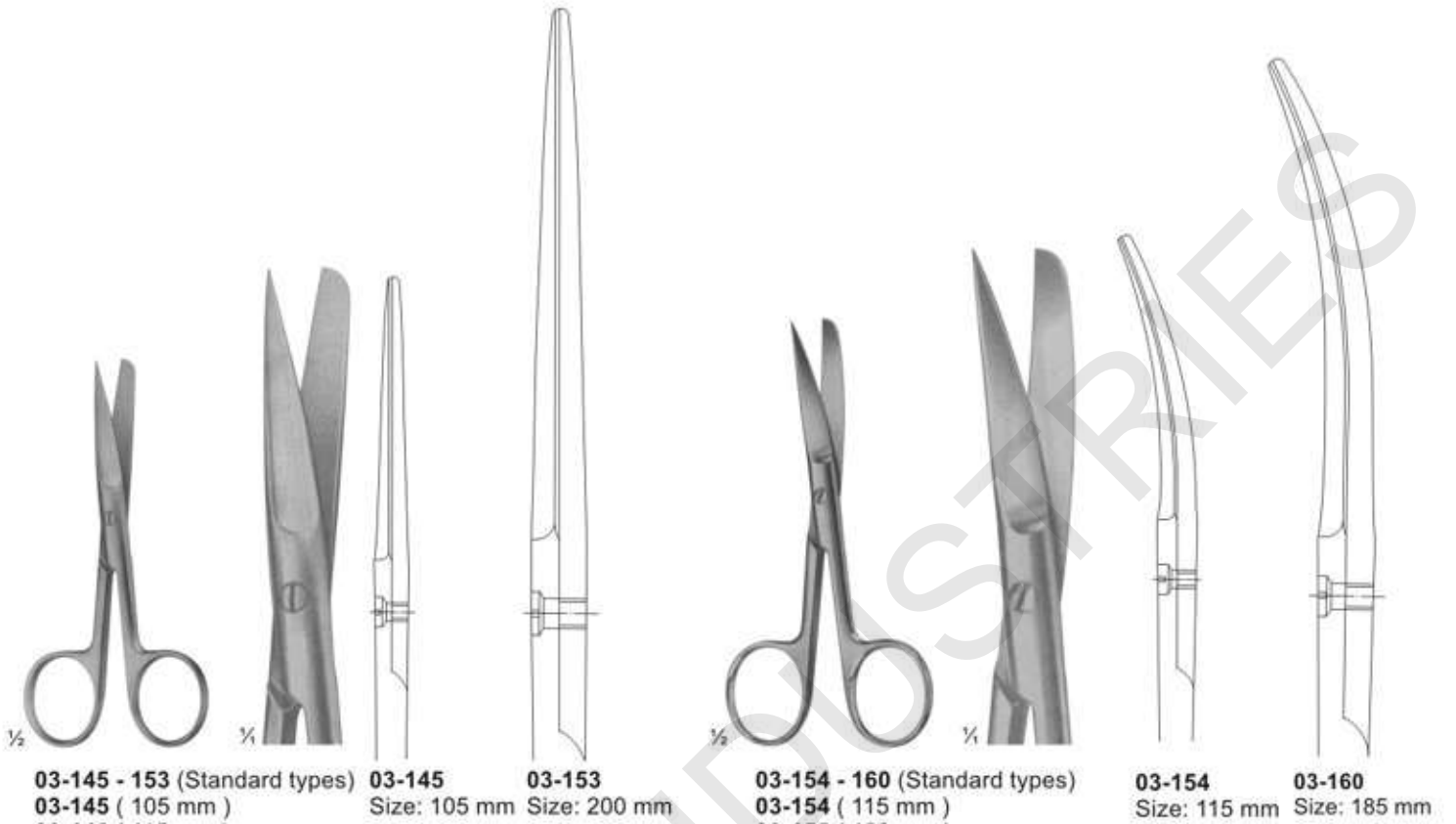

## Surgical Scissors



**03-167 - 169**  
DEAVER  
with flat lock

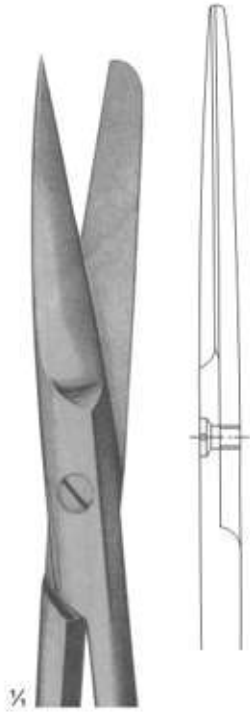

**03-167**  
Size: 145 mm

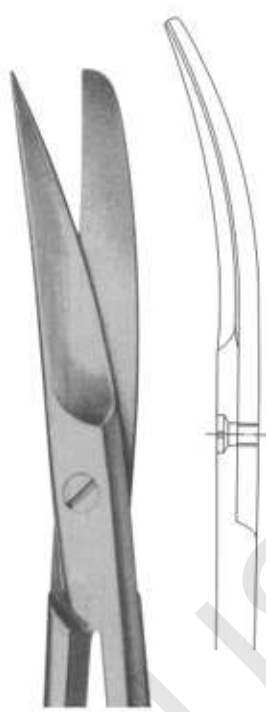

**03-168**  
Size: 145 mm

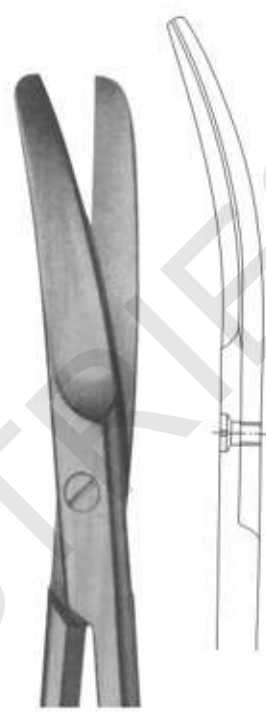

**03-169**  
Size: 145 mm



**03-170 - 172**  
Incision scissors

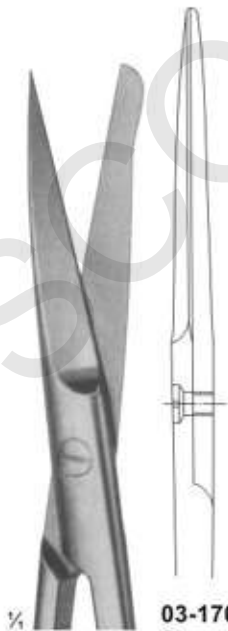

**03-170**  
Size: 130 mm



**03-171**  
Size: 145 mm



**03-172**  
Size: 165 mm



**03-173**  
SYSTRUNK  
Nail splitting scissors



**03-173**  
Size: 130 mm



# Dissecting Scissors



**03-174 - 175**  
**KILNER**  
 Special flat points for dissecting and undermining the skin

**03-176**  
**KILNER**  
 Fine dissecting scissors  
 Size: 115 mm

**03-177**  
**JAMESON**  
 Dissecting scissors  
 Size: 150 mm

**03-178**  
**REYNOLDS**  
 Dissecting scissors  
 Size: 145 - 175 mm

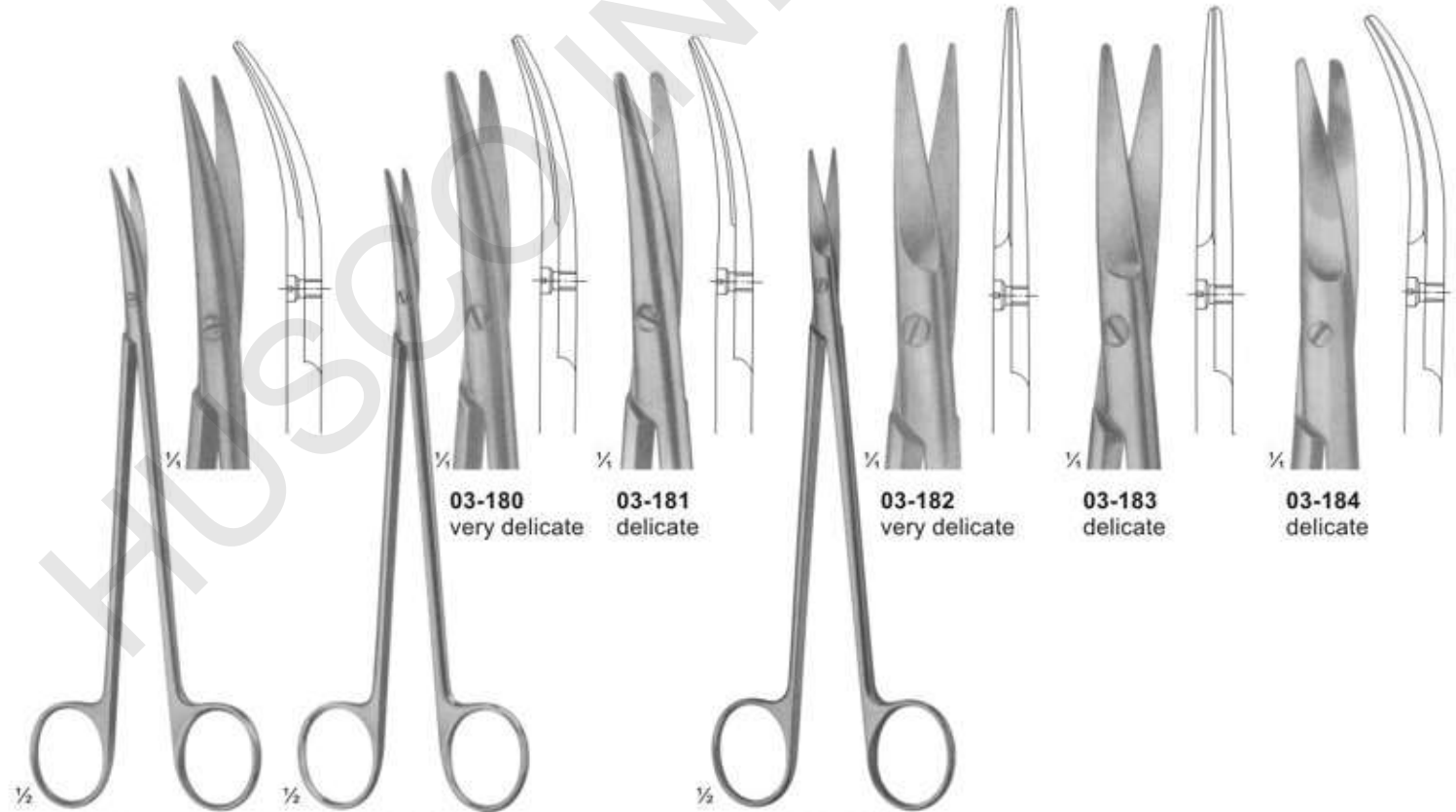

**03-179**  
**DE BAKEY**  
 Arteriotomy scissors  
 Size: 175 mm

**03-180 - 181**  
**TOENNIS ADSON**  
 Dissecting scissors  
 Size: 175 mm

**03-182 - 184**  
**TOENNIS**  
 Dissecting scissors  
 Size: 180 mm

## Dissecting Scissors

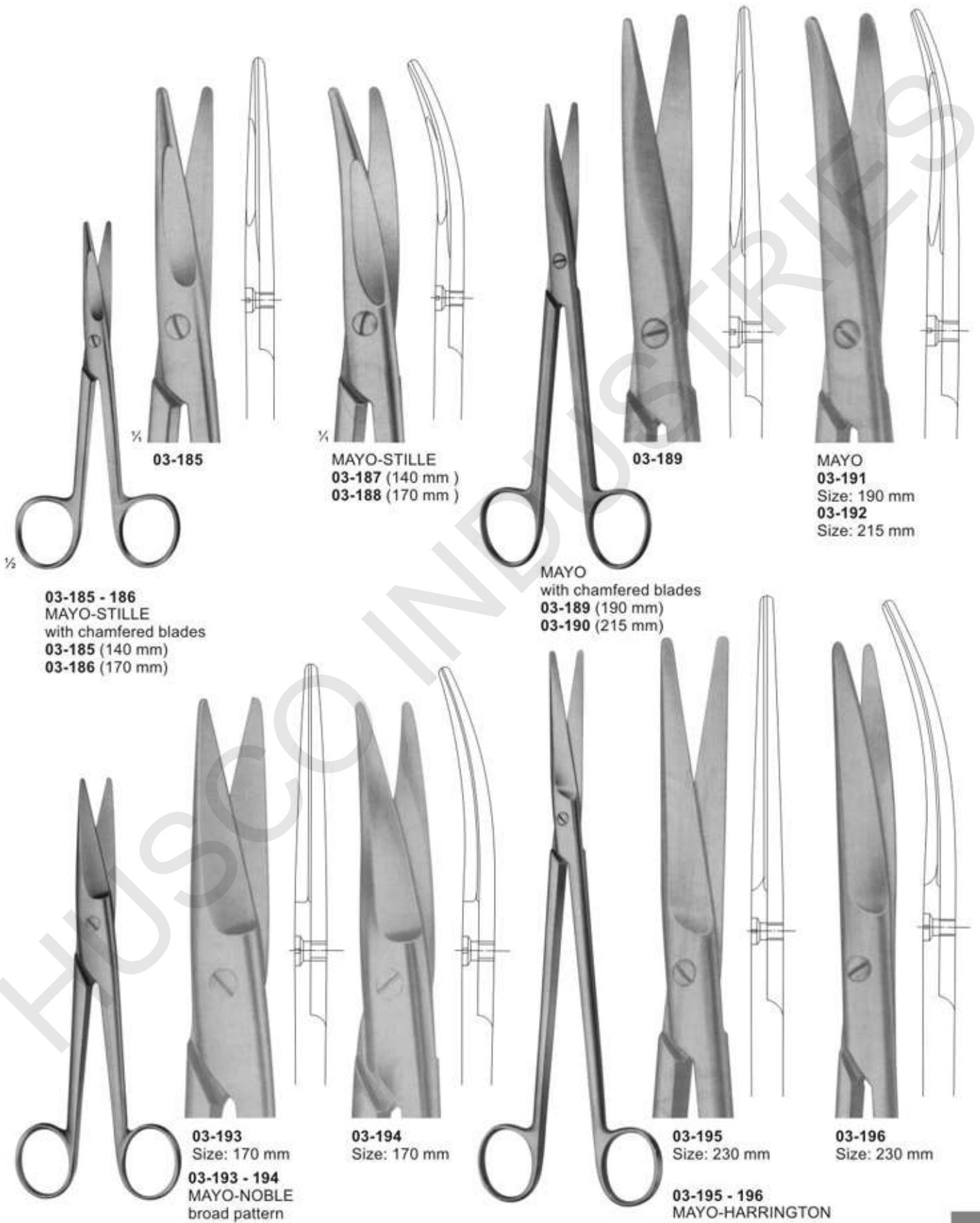

03-185

MAYO-STILLE  
03-187 (140 mm)  
03-188 (170 mm)

03-189

MAYO  
03-191  
Size: 190 mm  
03-192  
Size: 215 mm

03-185 - 186  
MAYO-STILLE  
with chamfered blades  
03-185 (140 mm)  
03-186 (170 mm)

MAYO  
with chamfered blades  
03-189 (190 mm)  
03-190 (215 mm)

03-193  
Size: 170 mm

03-194  
Size: 170 mm

03-195  
Size: 230 mm

03-196  
Size: 230 mm

03-193 - 194  
MAYO-NOBLE  
broad pattern

03-195 - 196  
MAYO-HARRINGTON

## Scissors for Cardiovascular and Neuro-Surgery



03-197  
OLIVECRONA  
Dura scissors



03-198  
STRULLY  
pointed  
Size: 220 mm

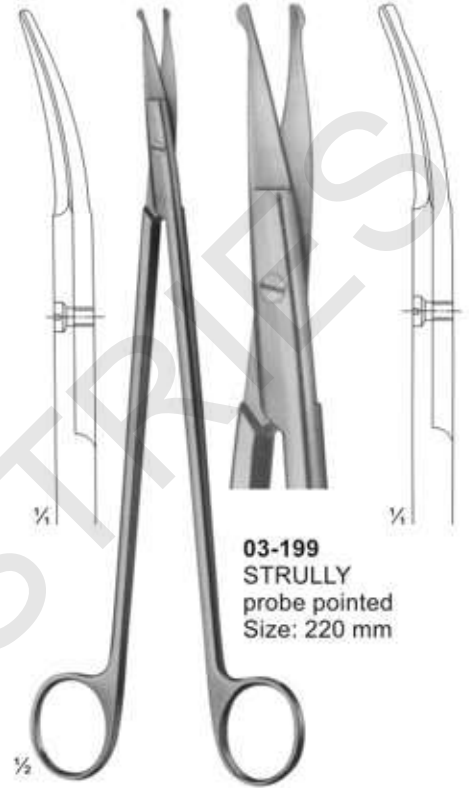

03-199  
STRULLY  
probe pointed  
Size: 220 mm

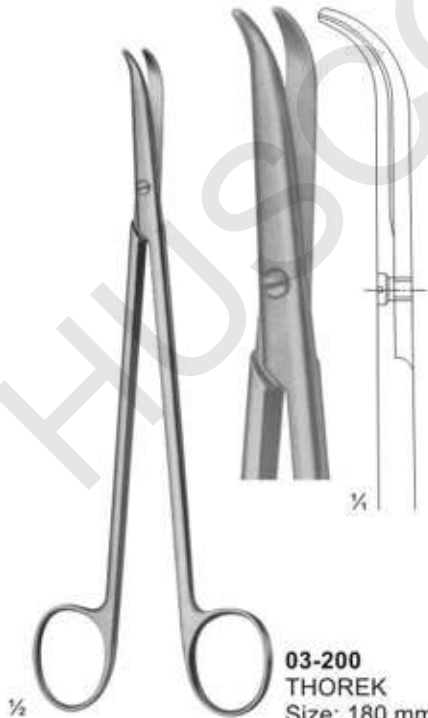

03-200  
THOREK  
Size: 180 mm

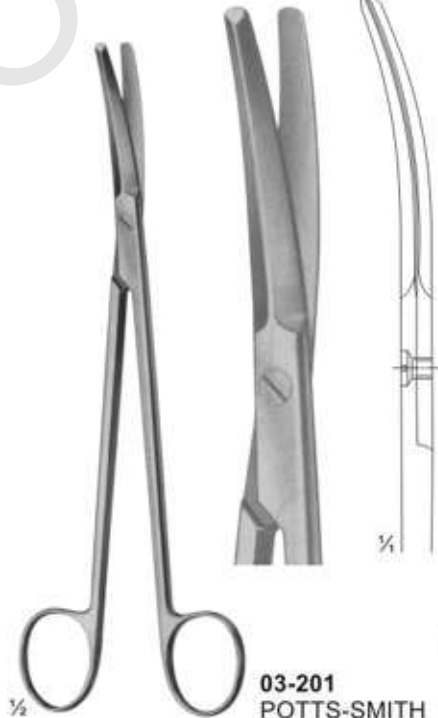

03-201  
POTTS-SMITH  
Size: 190 mm

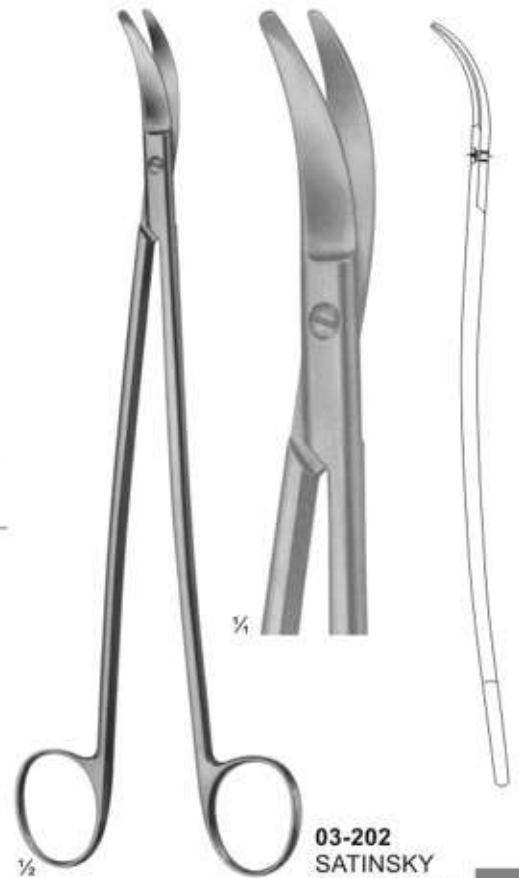

03-202  
SATINSKY  
Size: 245 mm

## Delicate, Nasal and Tonsil Scissors

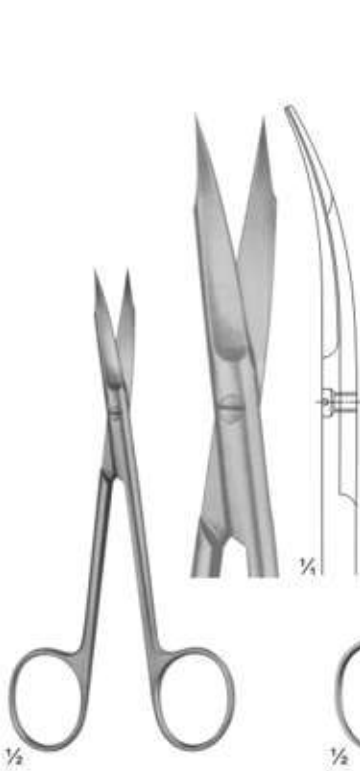

**03-203**  
1 finely toothed blade  
Size: 130 mm

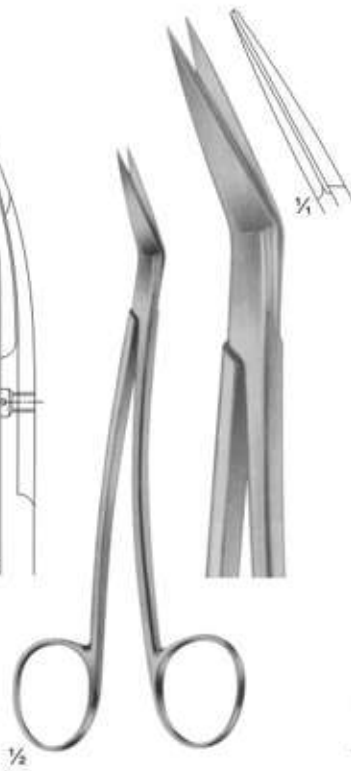

**03-204**  
LOCKLIN  
curved sideways,  
1 toothed blade  
Size: 155 mm



**03-205**  
FOMON  
blades serrated  
Size: 145 mm

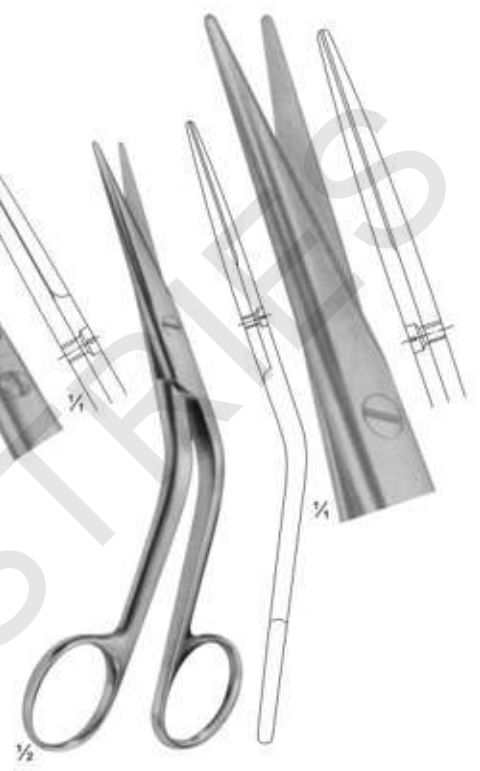

**03-206**  
COTTLE  
Size: 165 mm



**03-207**  
HEYMAN-KNIGHT  
Size: 175 mm

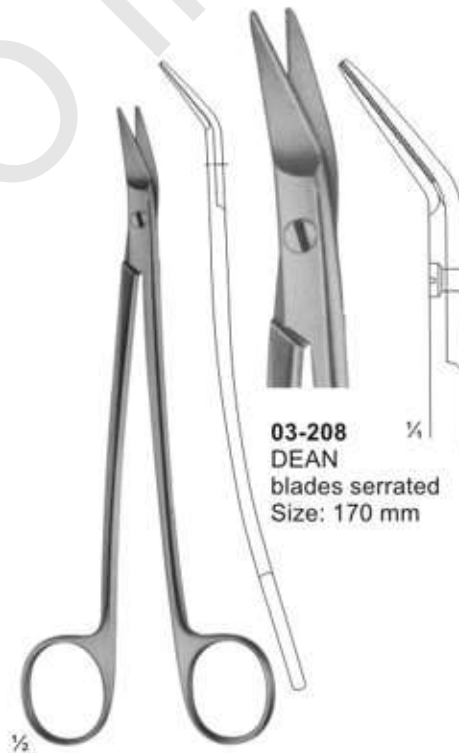

**03-208**  
DEAN  
blades serrated  
Size: 170 mm

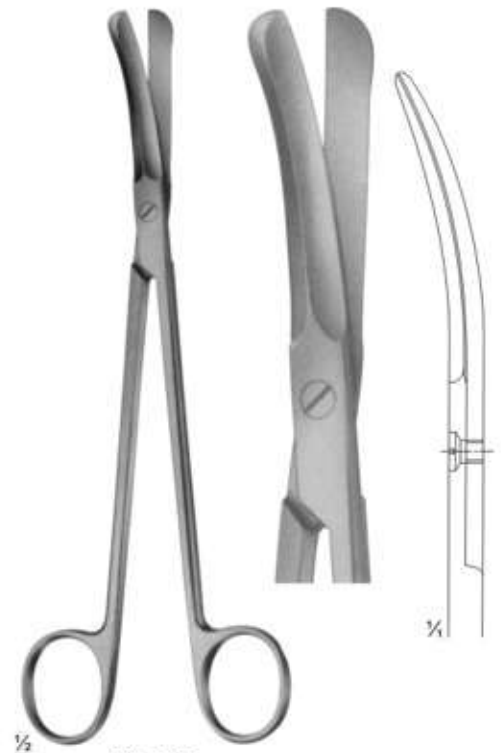

**03-209**  
GOOD  
Size: 195 mm

**Bone Shears**

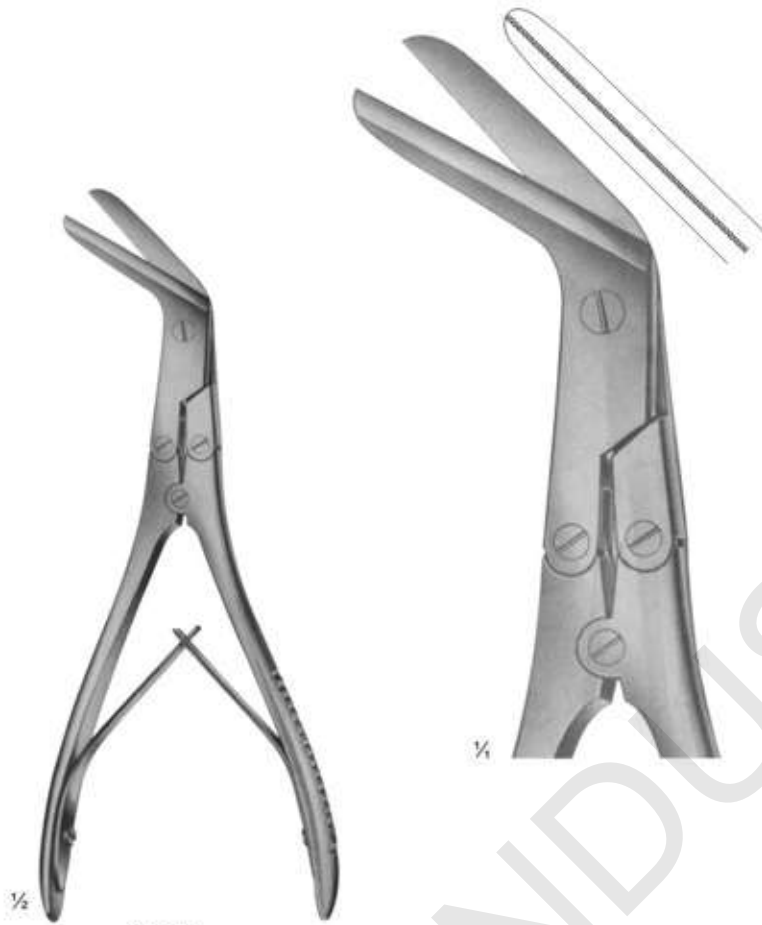

**03-210**  
KILLIAN  
Size: 200 mm



**03-211 - 03-212**



**03-211**  
195 mm



1/2



**03-212**  
225 mm



1/2

**Scissors for deep operations and for Gynaecology**

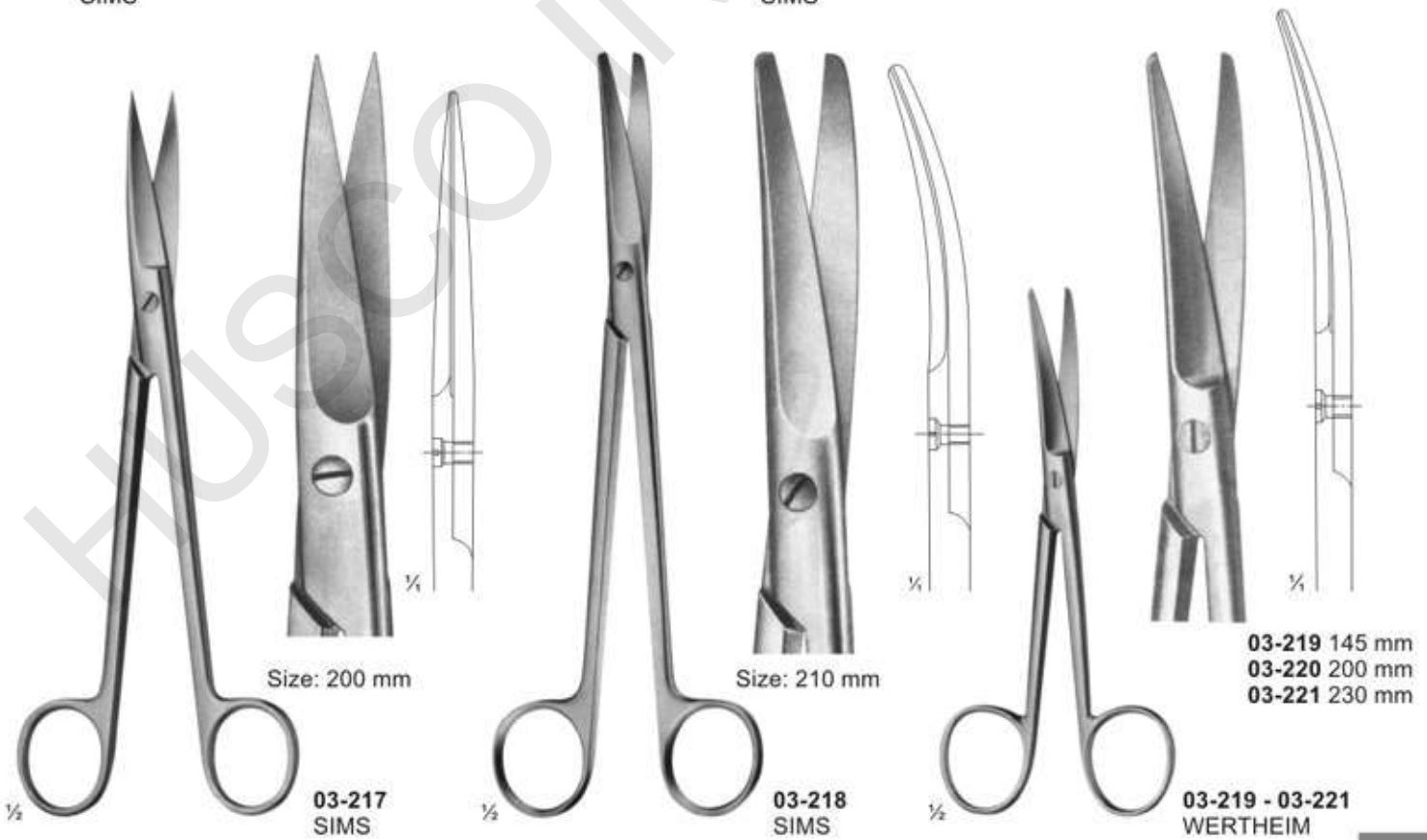
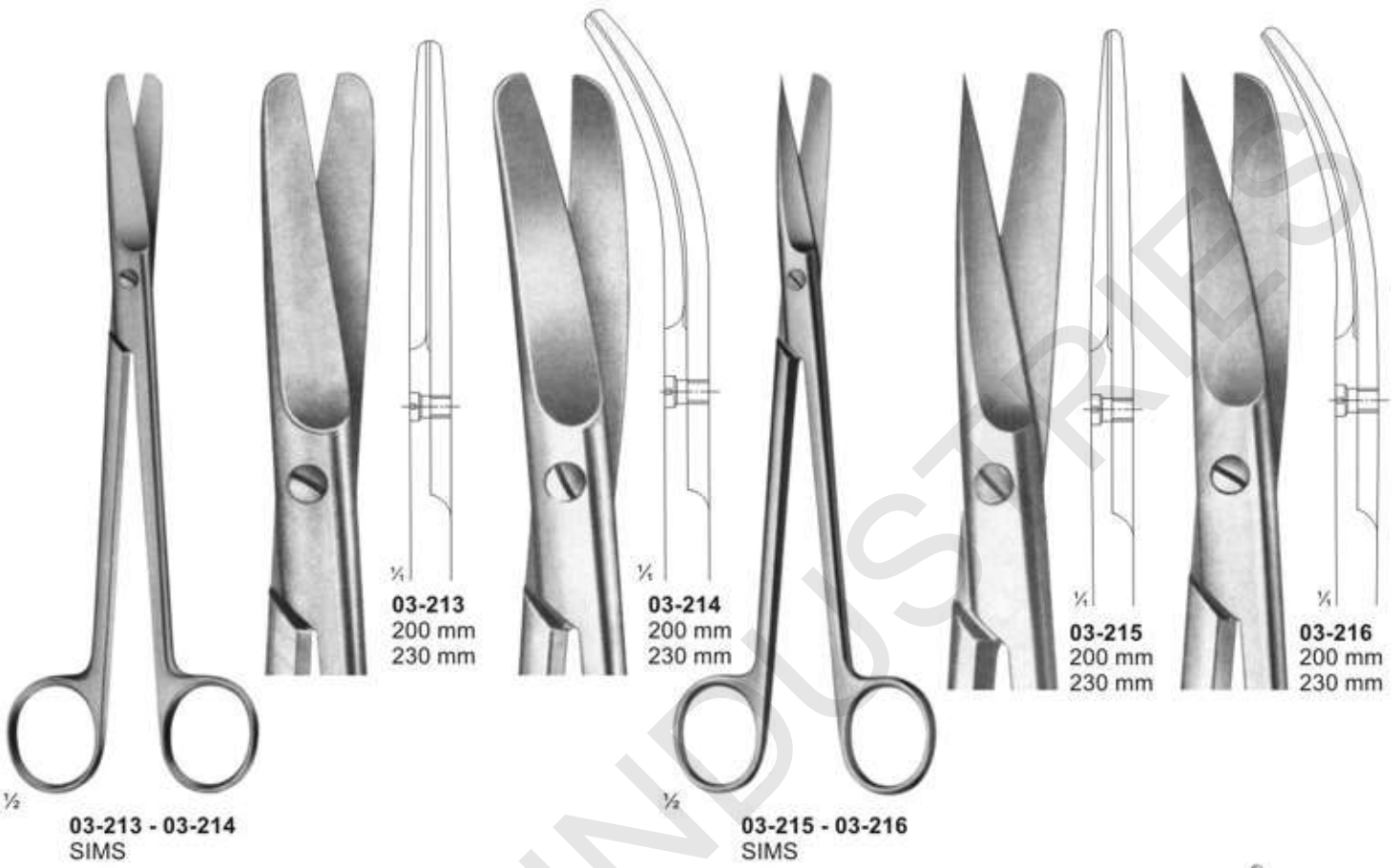

## Scissors for Obstetrics



**03-222**  
**SCHUMACHER**  
 Umbilical cord scissors  
 Size: 155 mm

**03-223**  
 Umbilical cord scissors  
 Size: 105 mm

**03-224**  
 Umbilical cord scissors  
 135 mm



**03-225 - 03-226**  
**BRAUN-STADLER**  
 Episiotomy scissors

**03-225**  
 145 mm

**03-226**  
 200 mm

**03-227**  
 Episiotomy scissors  
 240 mm

## Wire and Plate Scissors



**03-228 - 03-232**  
BEEBE  
Size: 110 mm



03-228

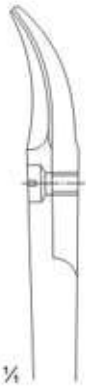

03-229



03-230  
broad blades



03-231  
1 blade serrated

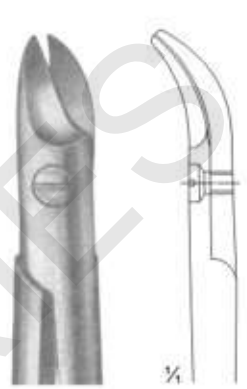

03-232  
NAUJOKS  
strongly curved

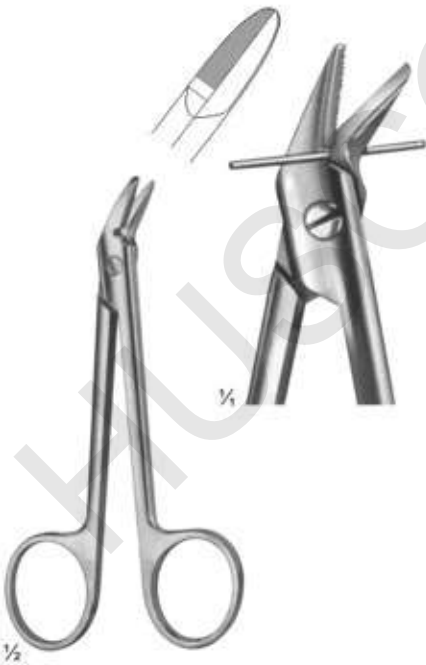

**03-233**  
1 blade serrated  
Size: 120 mm



**03-234**  
STRACK  
Size: 100 mm

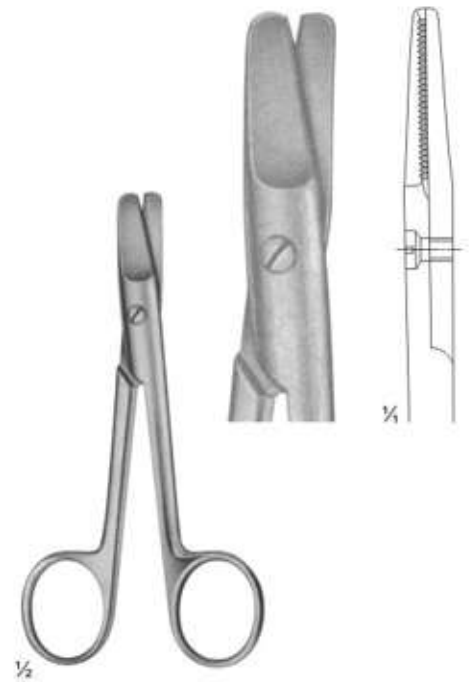

**03-235**  
HARVEY  
blades serrated  
Size: 125 mm



## Bandage and Cloth Scissors



1/2  
**03-236**  
Universal bandage and cloth scissors,  
with toothed edges  
180 mm



1/2  
**03-237**  
LISTER  
Universal bandage and cloth scissors,  
with toothed edges  
Size: 145 mm

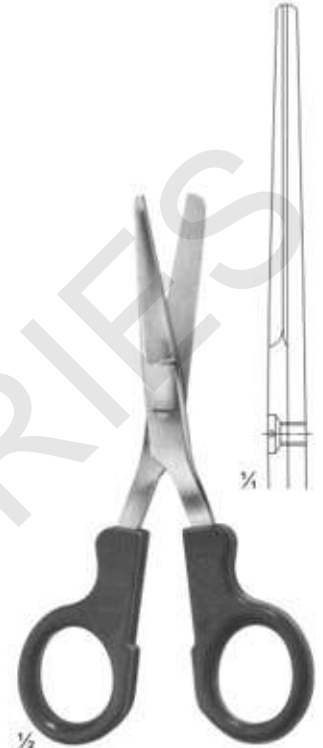

1/2  
**03-238**  
LISTER  
Nurse's scissors  
Size: 145 mm

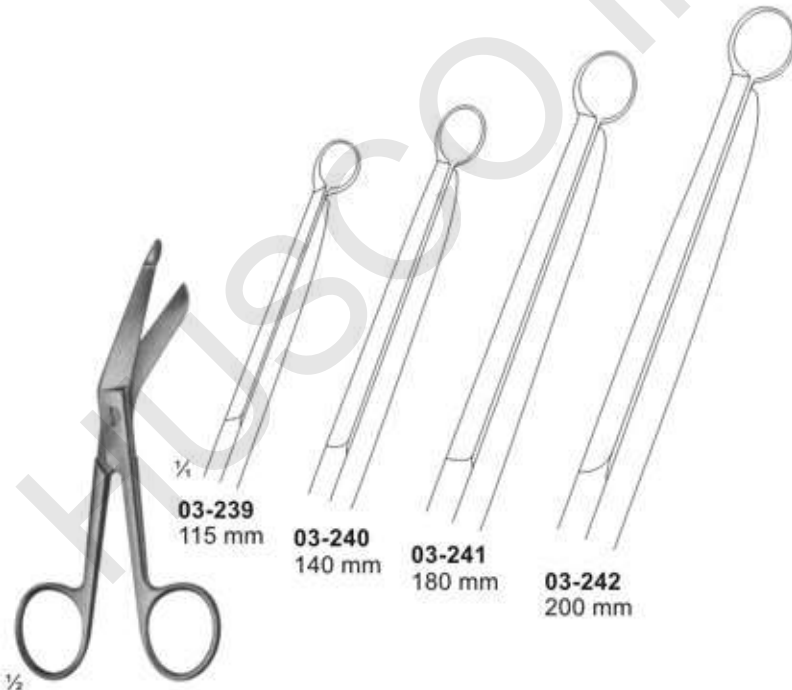

1/2  
**03-239**  
115 mm  
**03-240**  
140 mm  
**03-241**  
180 mm  
**03-242**  
200 mm  
**03-239 - 03-242**  
LISTER

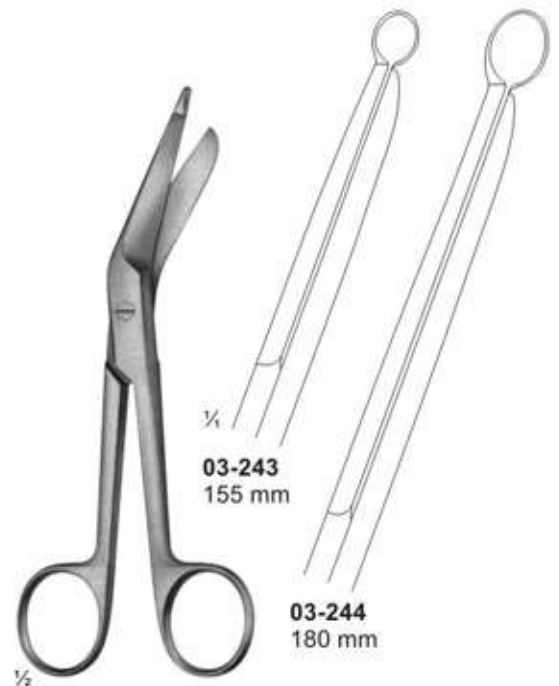

1/2  
**03-243**  
155 mm  
**03-244**  
180 mm  
**03-243 - 03-244**  
LISTER

## Bandage-, Cloth-, and Plaster Scissors



**03-245**  
CLOTH SCISSORS  
205 mm



**03-246**  
BRAUN-STADLER  
225 mm

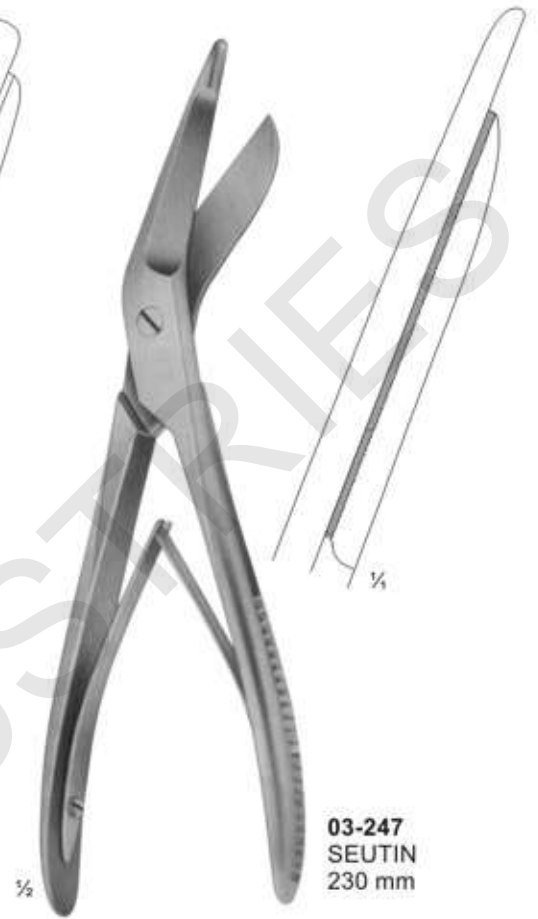

**03-247**  
SEUTIN  
230 mm



**03-248** 200 mm  
**03-249** 230 mm

**03-248 - 03-249**  
ESMARCH

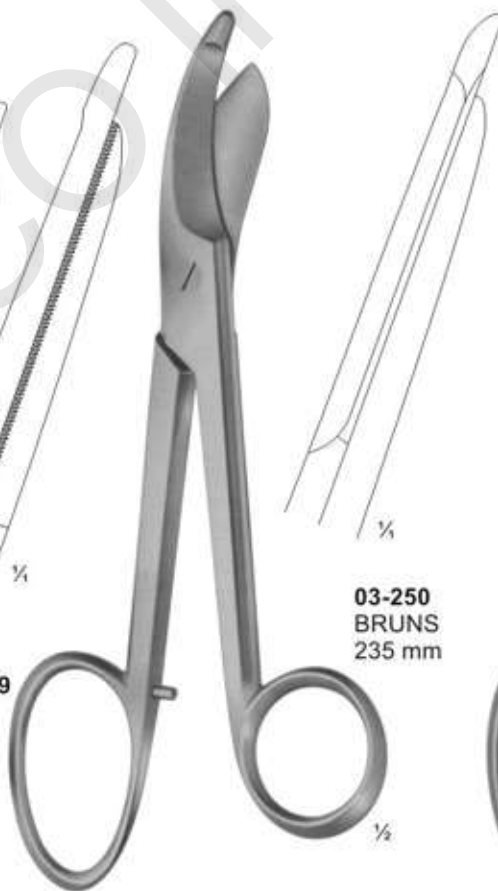

**03-250**  
BRUNS  
235 mm

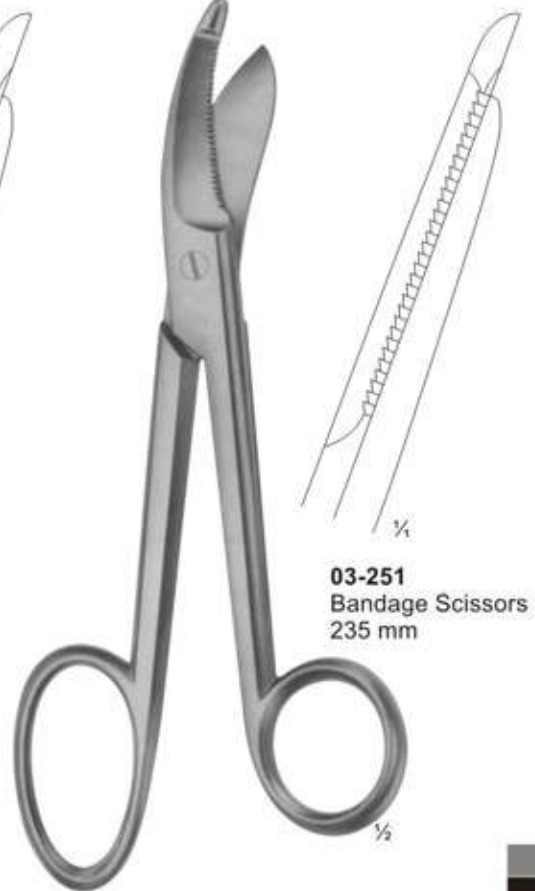

**03-251**  
Bandage Scissors  
235 mm

## Forceps for grasping tissue, tumors etc.



**04-101 - 103**  
YASARGIL-SAMII  
Jaws spoon-shaped  
240 mm

**04-104 - 105**  
YASARGIL  
Jaws spoon-shaped  
220 mm

**04-106 - 108**  
SAMII  
Jaws spoon-shaped  
230 mm

**04-109 - 111**  
SAMII  
Jaws spoon-shaped  
230 mm

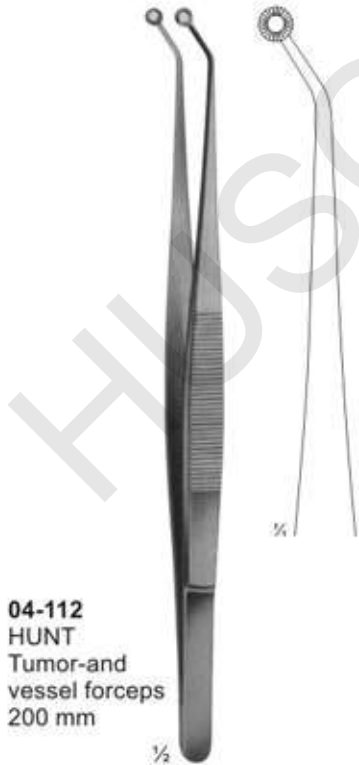

**04-112**  
HUNT  
Tumor-and  
vessel forceps  
200 mm



**04-113**  
HUNT  
Tumor-and  
vessel forceps  
200 mm



**04-114**  
YASARGIL  
Tumor-and  
vessel forceps  
200 mm

## Delicate Dissecting, Microscopic, Sterilizing Forceps



**04-115**  
THORPE  
Corneal forceps  
120 mm



**04-116**  
MICRO-ADSON  
120 mm

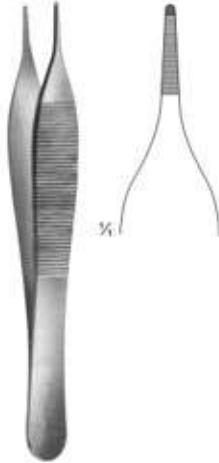

**04-117**  
ADSON  
120 mm



**04-118**  
MICRO-ADSON  
150 mm

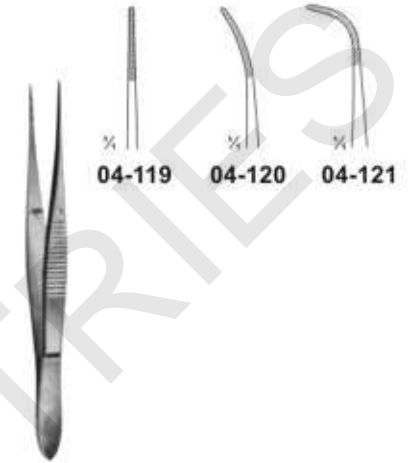

**04-119 - 121**  
100 mm



**04-122**  
BONACCOLTO  
110 mm

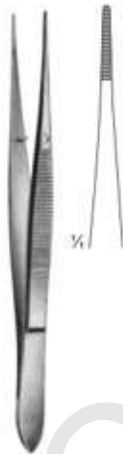

**04-123**  
115 mm



**04-124 - 133**

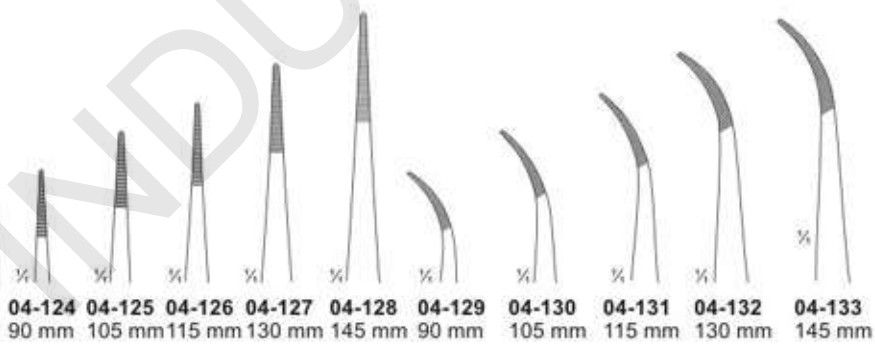

**04-124** 90 mm **04-125** 105 mm **04-126** 115 mm **04-127** 130 mm **04-128** 145 mm **04-129** 90 mm **04-130** 105 mm **04-131** 115 mm **04-132** 130 mm **04-133** 145 mm



**04-134**  
100 mm



**04-135**  
100 mm



**04-136**  
100 mm



**04-137**  
KUHNE  
Cover glass forceps, 105 mm



**04-138**  
160 mm

## Delicate Dissecting Forceps

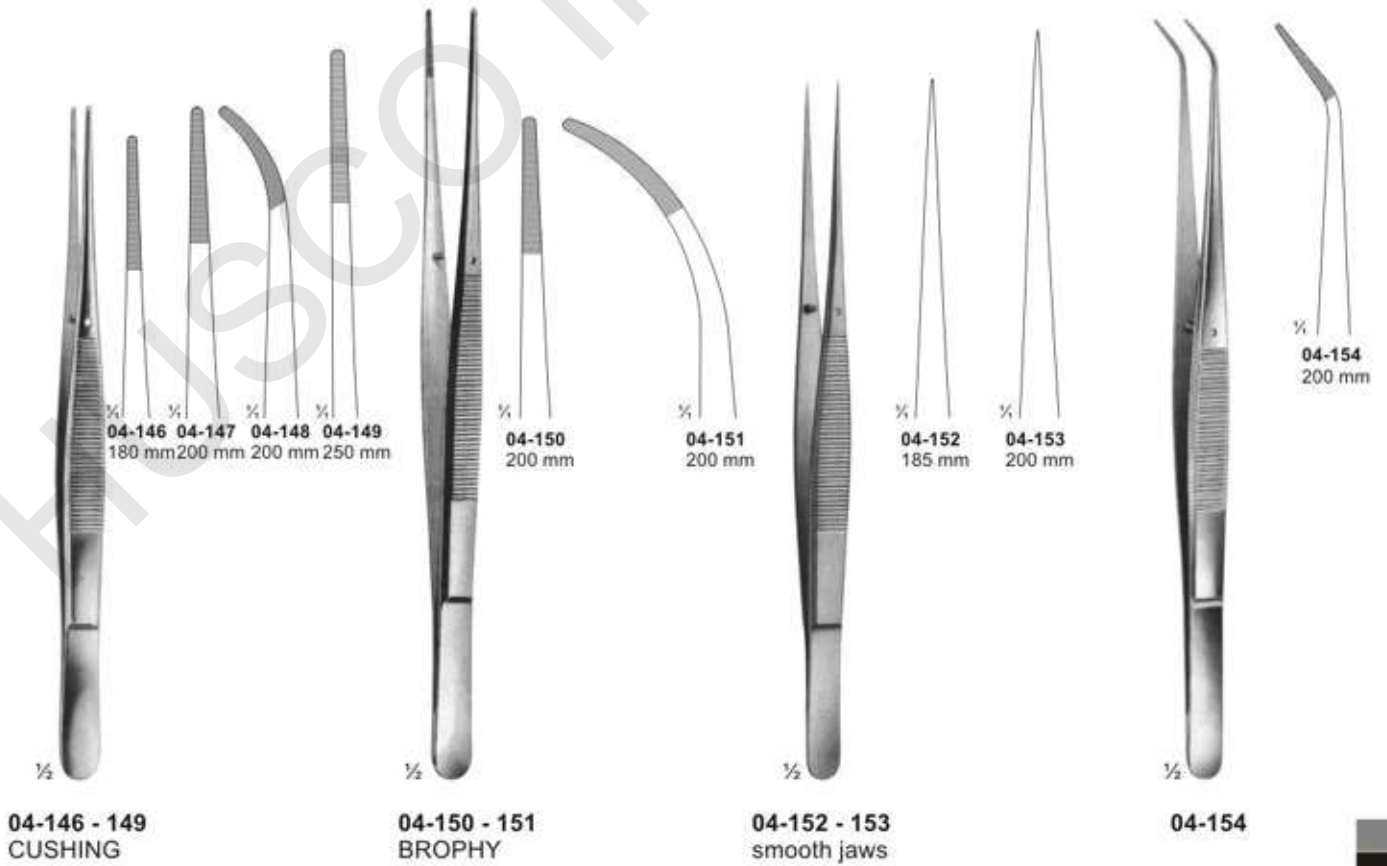
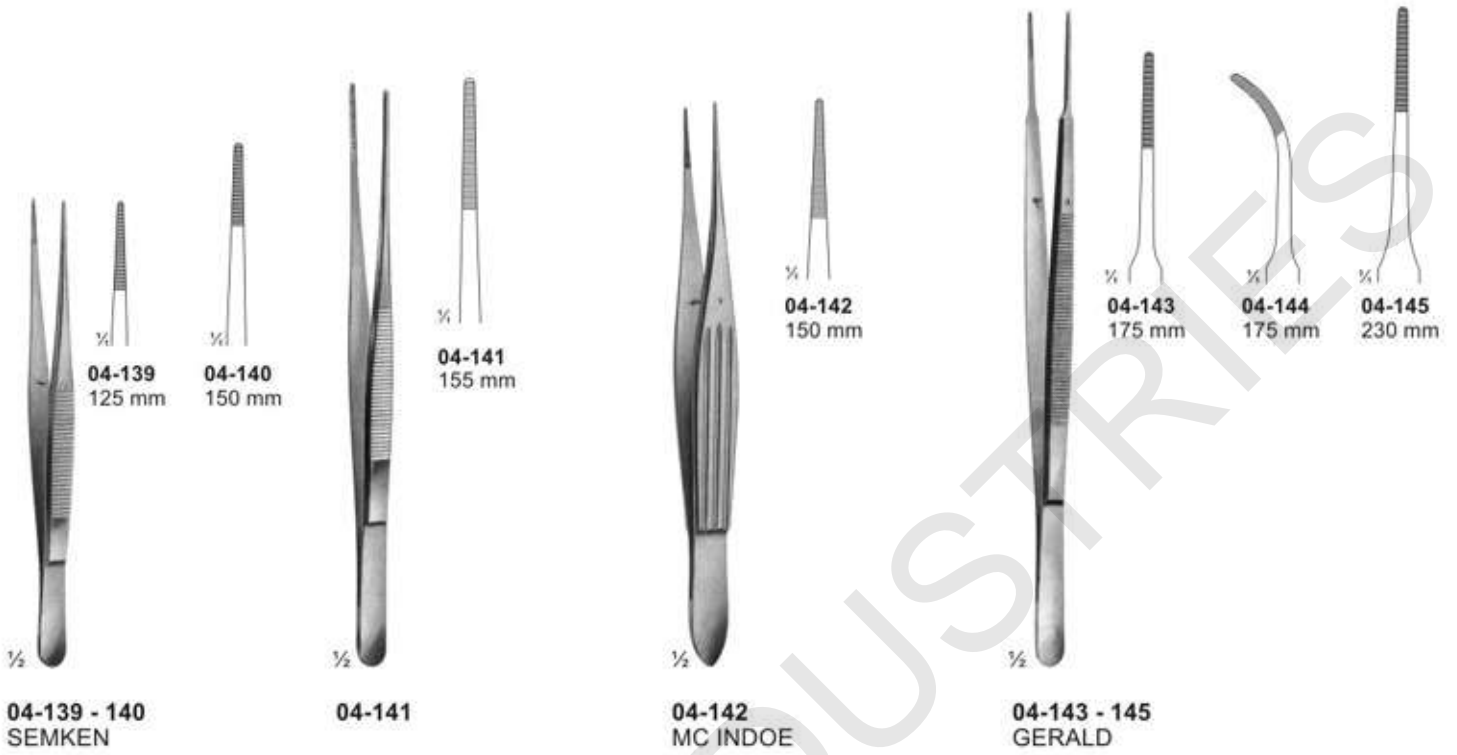

# Dissecting Forceps



1/2

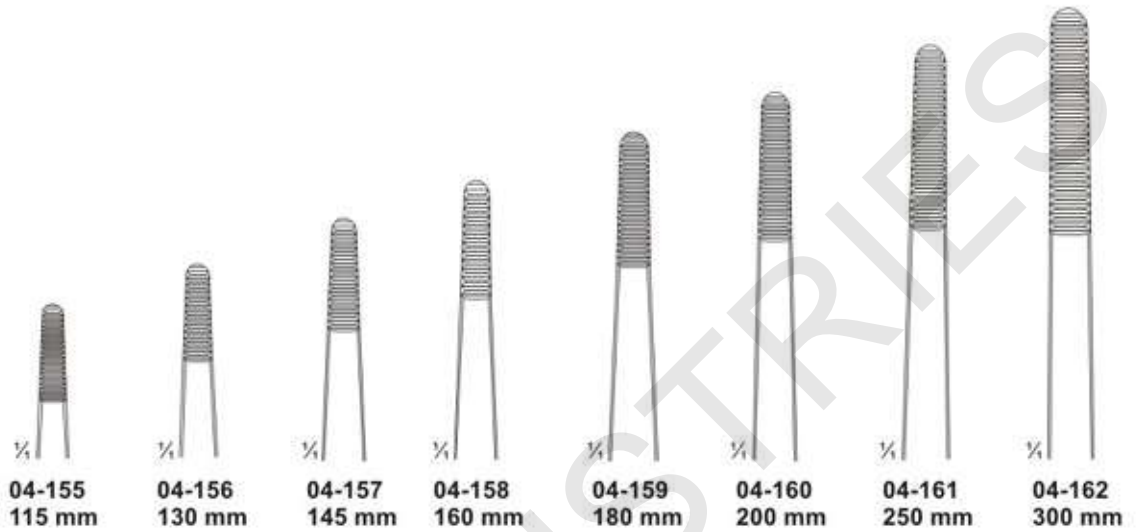

**04-155** 115 mm   
 **04-156** 130 mm   
 **04-157** 145 mm   
 **04-158** 160 mm   
 **04-159** 180 mm   
 **04-160** 200 mm   
 **04-161** 250 mm   
 **04-162** 300 mm

**04-155 - 04-162**  
STANDARD



1/2

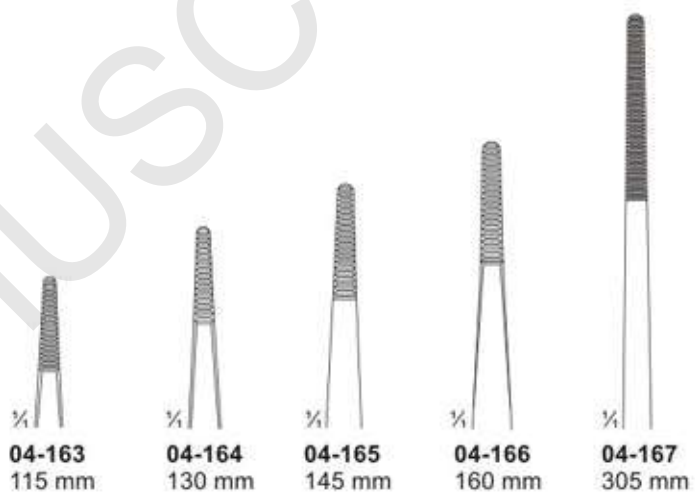

**04-163** 115 mm   
 **04-164** 130 mm   
 **04-165** 145 mm   
 **04-166** 160 mm   
 **04-167** 305 mm

**04-163 - 04-167**  
MEDIUM



1/2

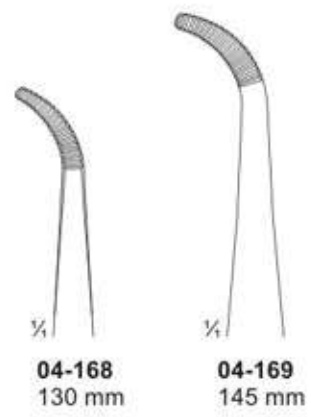

**04-168** 130 mm   
 **04-169** 145 mm

**04-168 - 04-169**  
MEDIUM

# Forceps

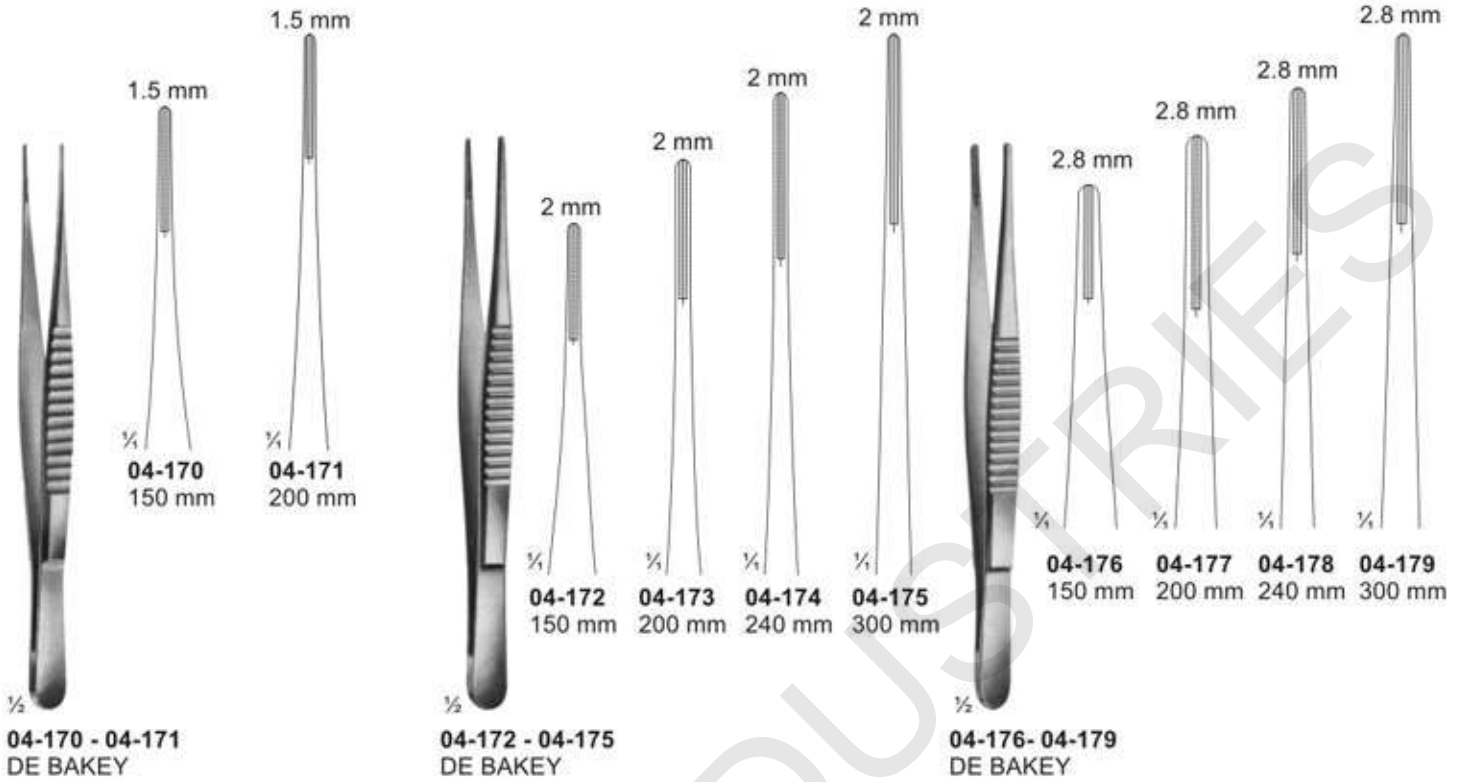

## Delicate Tissue Forceps



**04-185**  
BISHOP-HARMON  
85 mm

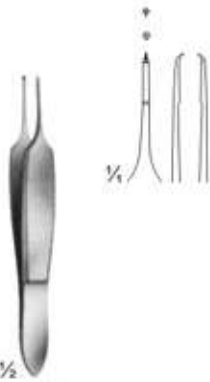

**04-186**  
ST.MARTIN  
80 mm



**04-187**  
CASTROVIEJO  
teeth 0.9 mm  
100 mm



**04-188**  
CASTROVIEJO  
teeth 0.5 mm  
100 mm



**04-189**  
ELSCHING  
110 mm



**04-190**  
GILL  
75 mm



**04-191**  
GILL - HESS  
75 mm

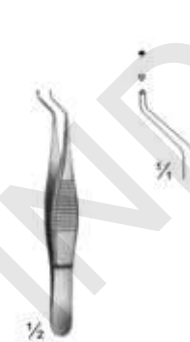

**04-192**  
HESS  
70 mm

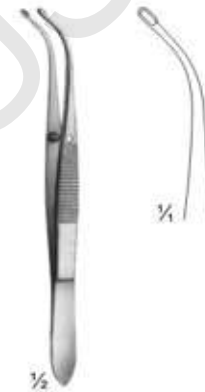

**04-193**  
ARRUGA  
100 mm



**04-194**  
SEMKEN  
125 mm  
125 mm  
150 mm  
2 X 3 teeth



**04-195**  
MICRO-ADSON  
120 mm

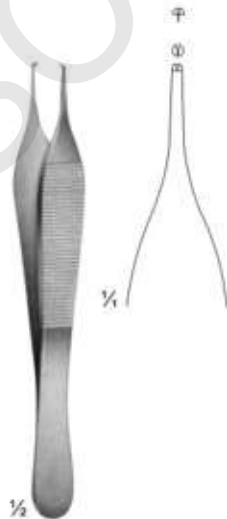

**04-196**  
ADSON  
120 mm



**04-197**  
ADSON  
120 mm



**04-198**  
ADSON  
120 mm



**04-199**  
ADSON  
150 mm



# Tissue Forceps

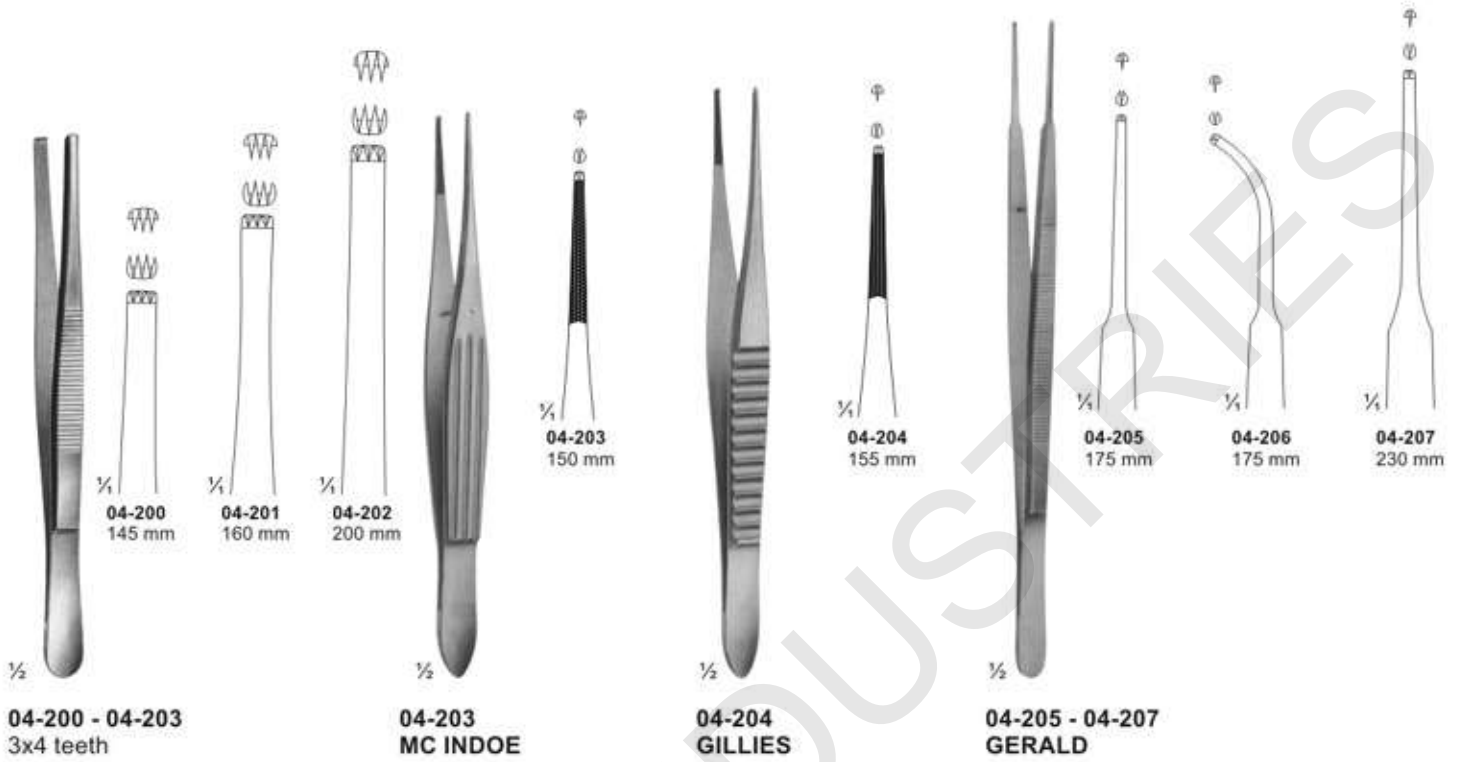

# Tissue Forceps



**04-213**  
**ADSON - BROWN**  
 Non-traumatic  
 120 mm

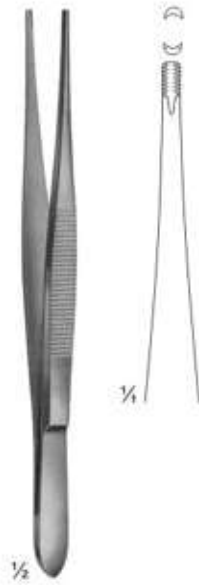

**04-214**  
**BROWN**  
 120 mm



**04-215**  
**GRAEFE**  
 110 mm



**04-216**  
**GRAEFE**  
 With Catch  
 110 mm

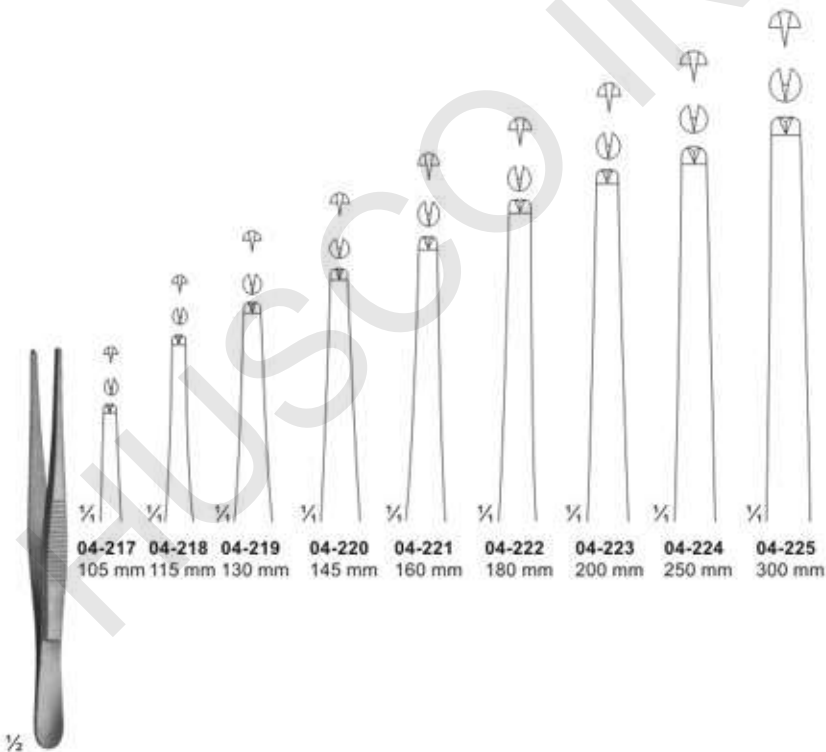

**04-217 - 04-225**  
**STANDARD**

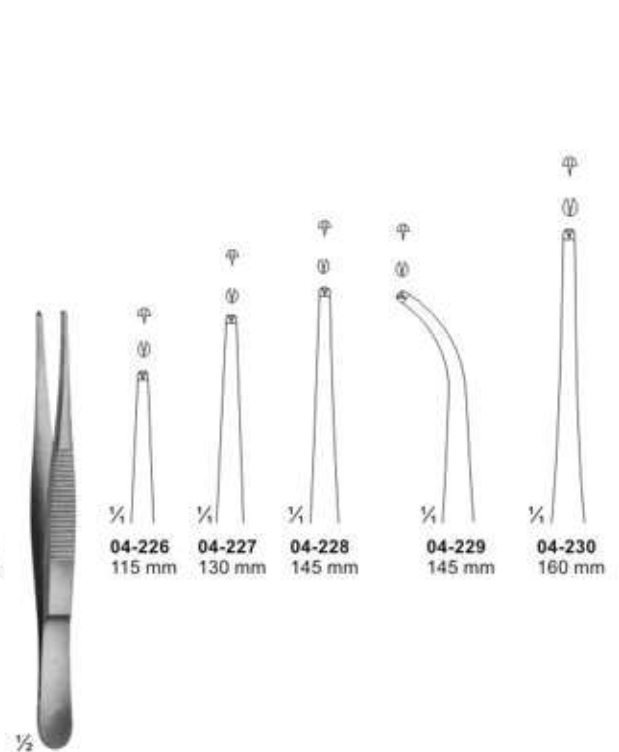

**04-226 - 04-230**  
**GRAEFE**  
 110 mm

## Forceps, Bayonet - Shaped



**04-231**  
LUCAE  
140 mm



**04-232**  
LUCAE  
1x2 teeth  
140 mm



**04-233**  
COTTLE  
Forceps with  
jaws toothed  
and serrated  
140 mm



**04-234**  
JANSEN  
160 mm



**04-235**  
GRUENWALD  
200 mm



**04-236**  
1x2 teeth  
200 mm



**04-237**  
TROELTSCH  
100 mm



**04-238**  
TROELTSCH  
115 mm



**04-239**  
TROELTSCH  
1X2 teeth  
115 mm

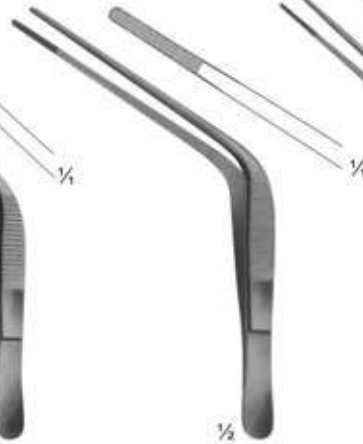

**04-240**  
WILDE  
115 mm



**04-241**  
TROELTSCH  
Cross action  
120 mm



**04-242**  
TROELTSCH  
140 mm

# Tissue Forceps, Lung Dissecting Forceps

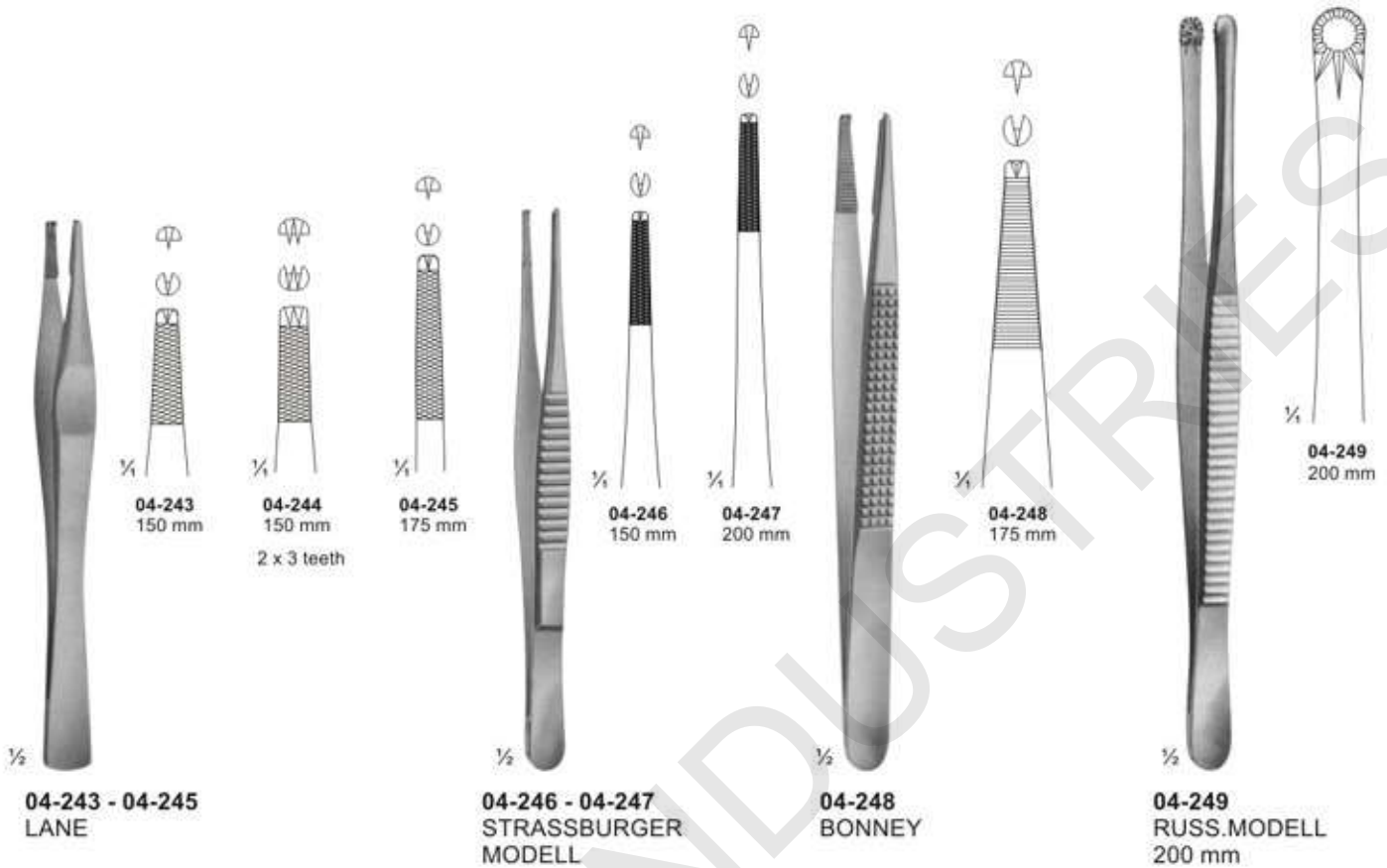

## Splinter and Cilia Forceps

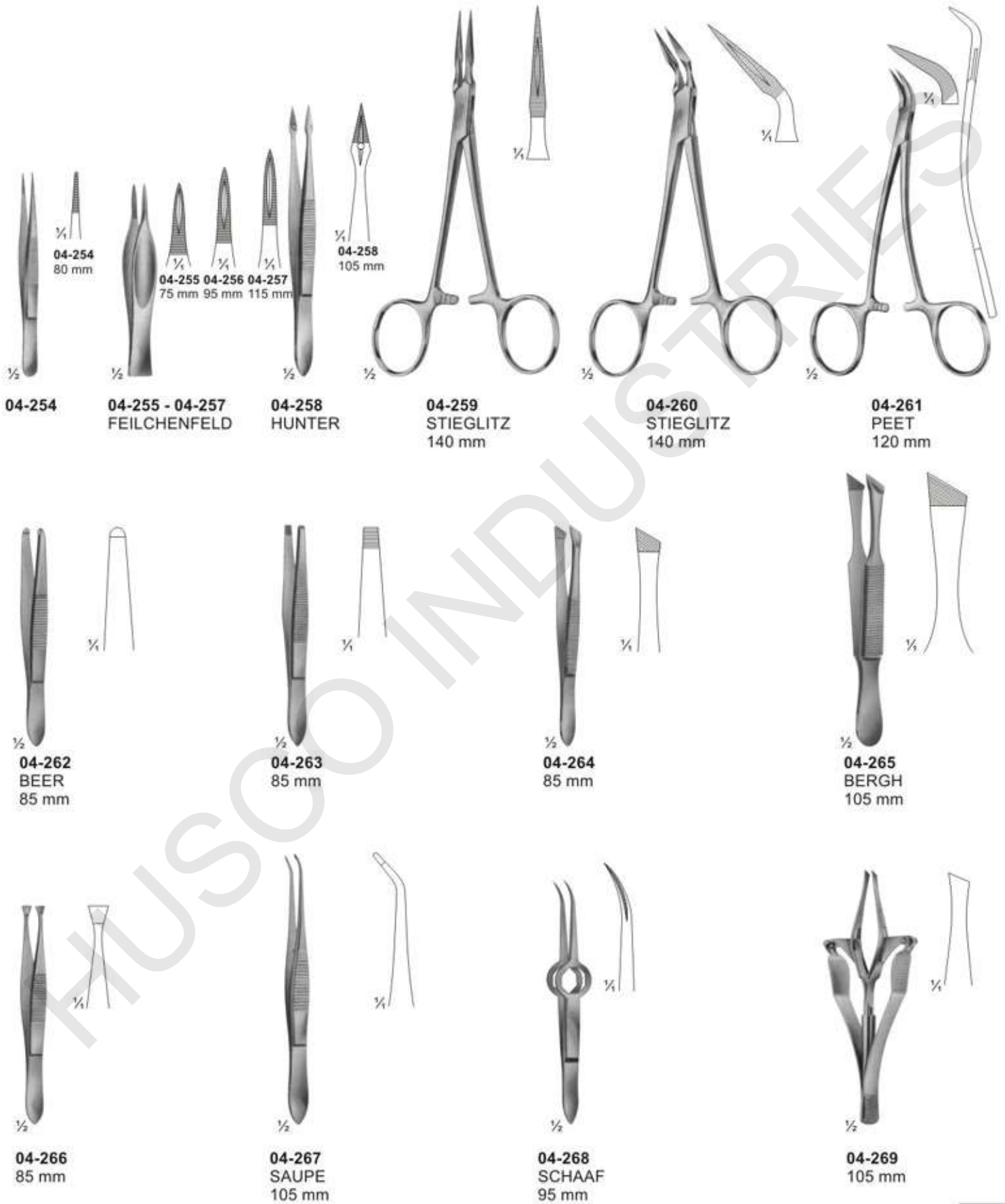

## Sponge and Dressing Forceps

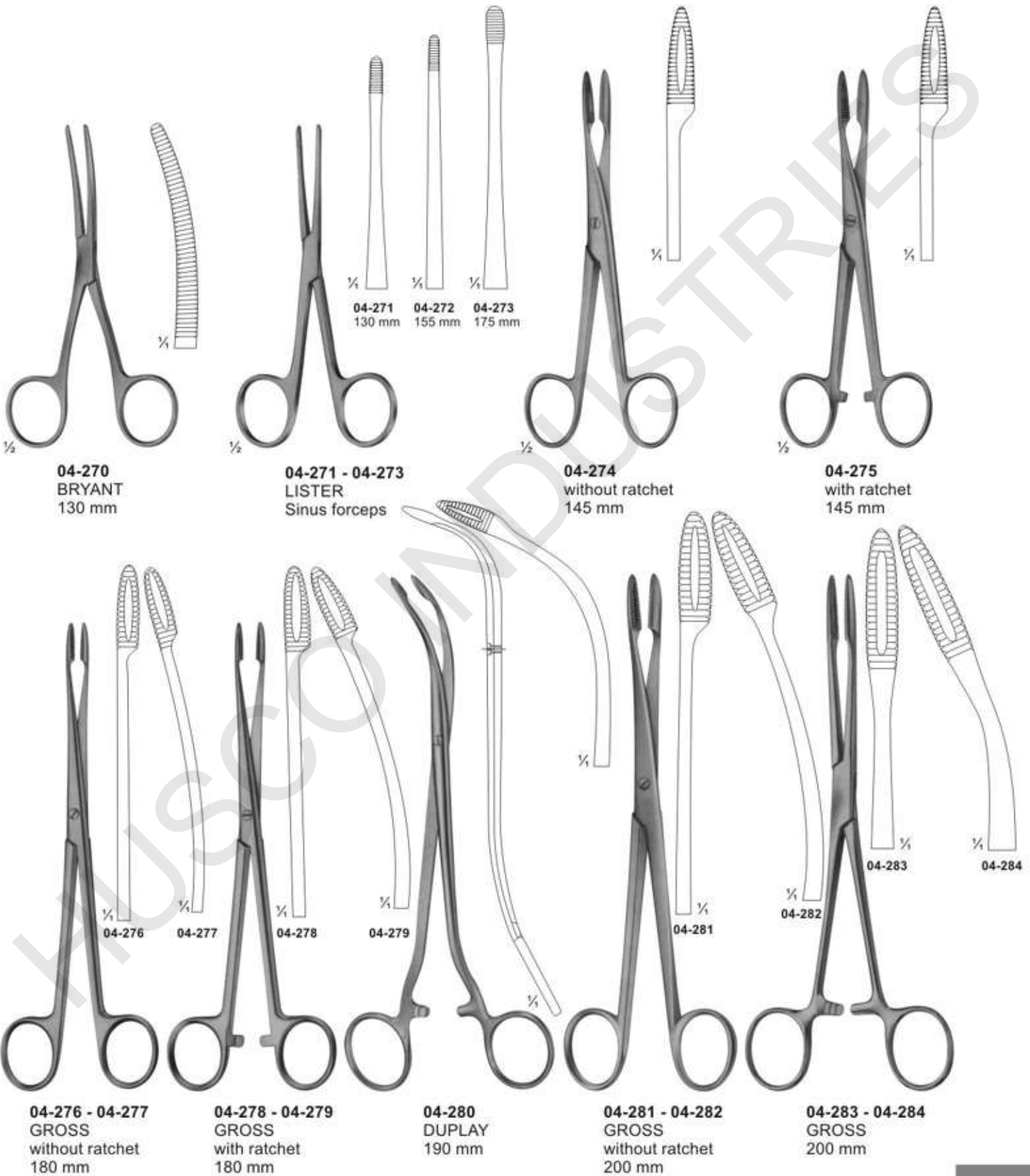

**Dressing-, Sponge holding-, Organ- and Tissue Grasping Forceps**

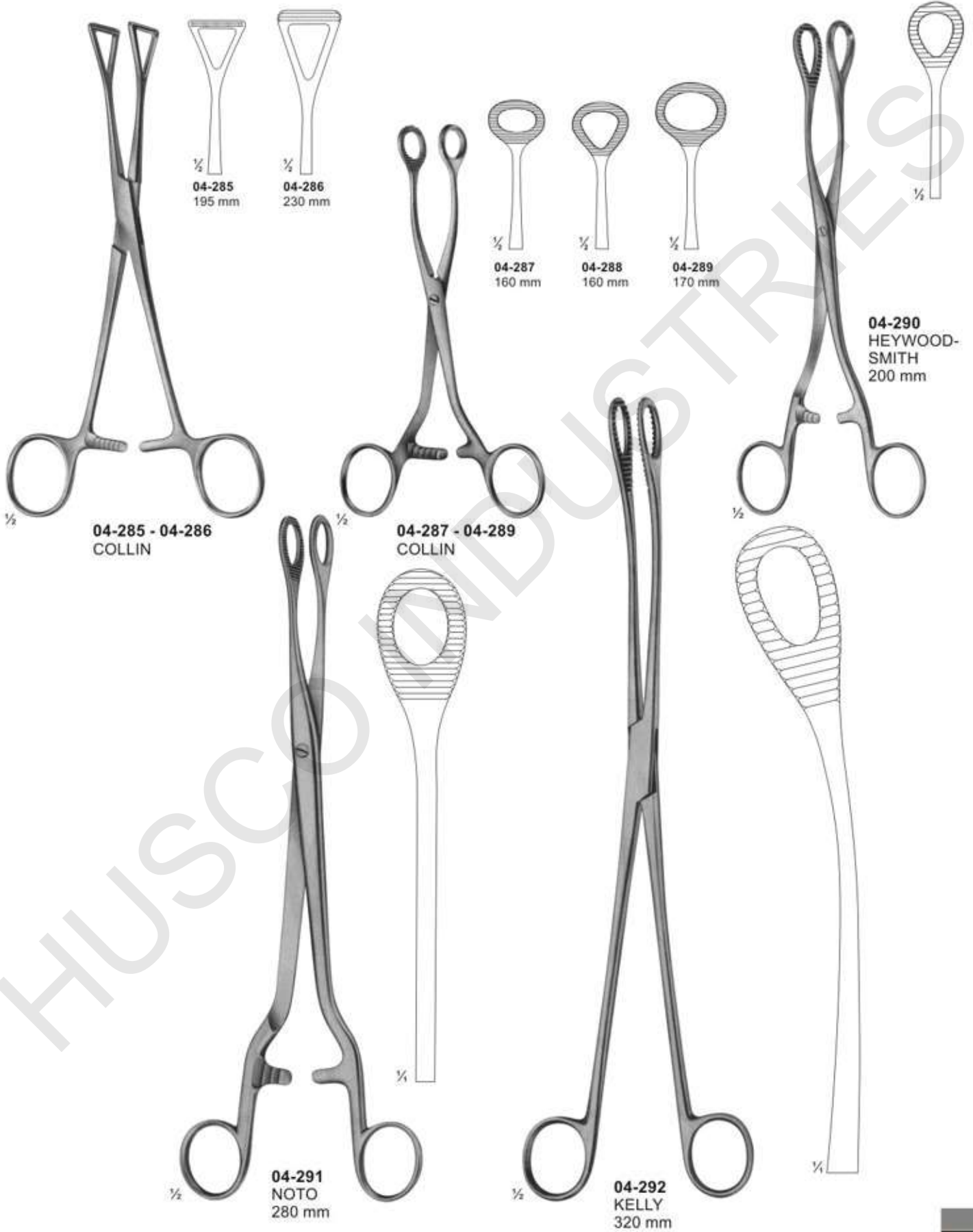

**Dressing, Sponge holding, Organ and Tissue Grasping Forceps**

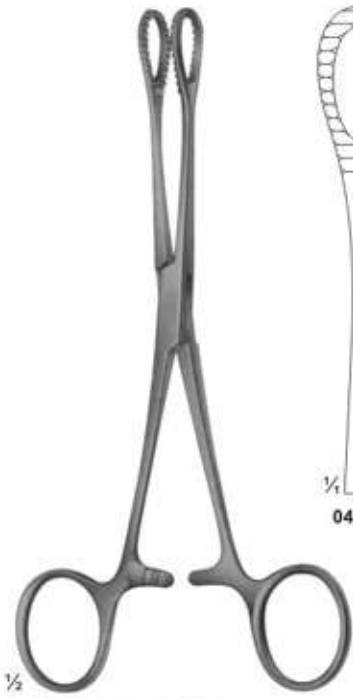

**04-293 - 04-294**  
FOERSTER-BALLENGER  
180 mm



04-293



04-294



**04-295 - 04-296**  
RAMPLEY



04-295  
180 mm



04-296  
250 mm



**04-297 - 04-300**  
FOERSTER-BALLENGER  
240 mm



04-297  
Smooth Jaws



04-298

Smooth Jaws



04-299

Serrated Jaws



04-300

Serrated Jaws

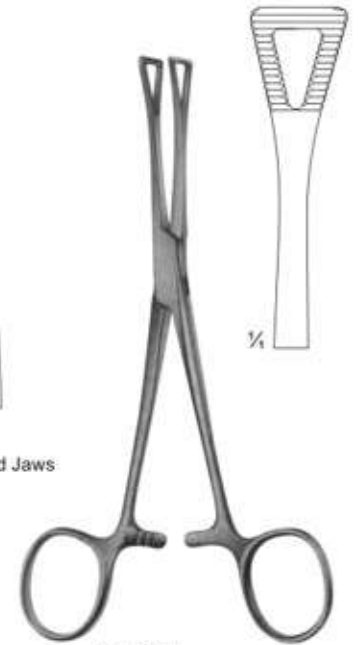

**04-301**  
PENNINGTON  
155 mm



04-301



## Intestinal Grasping Forceps

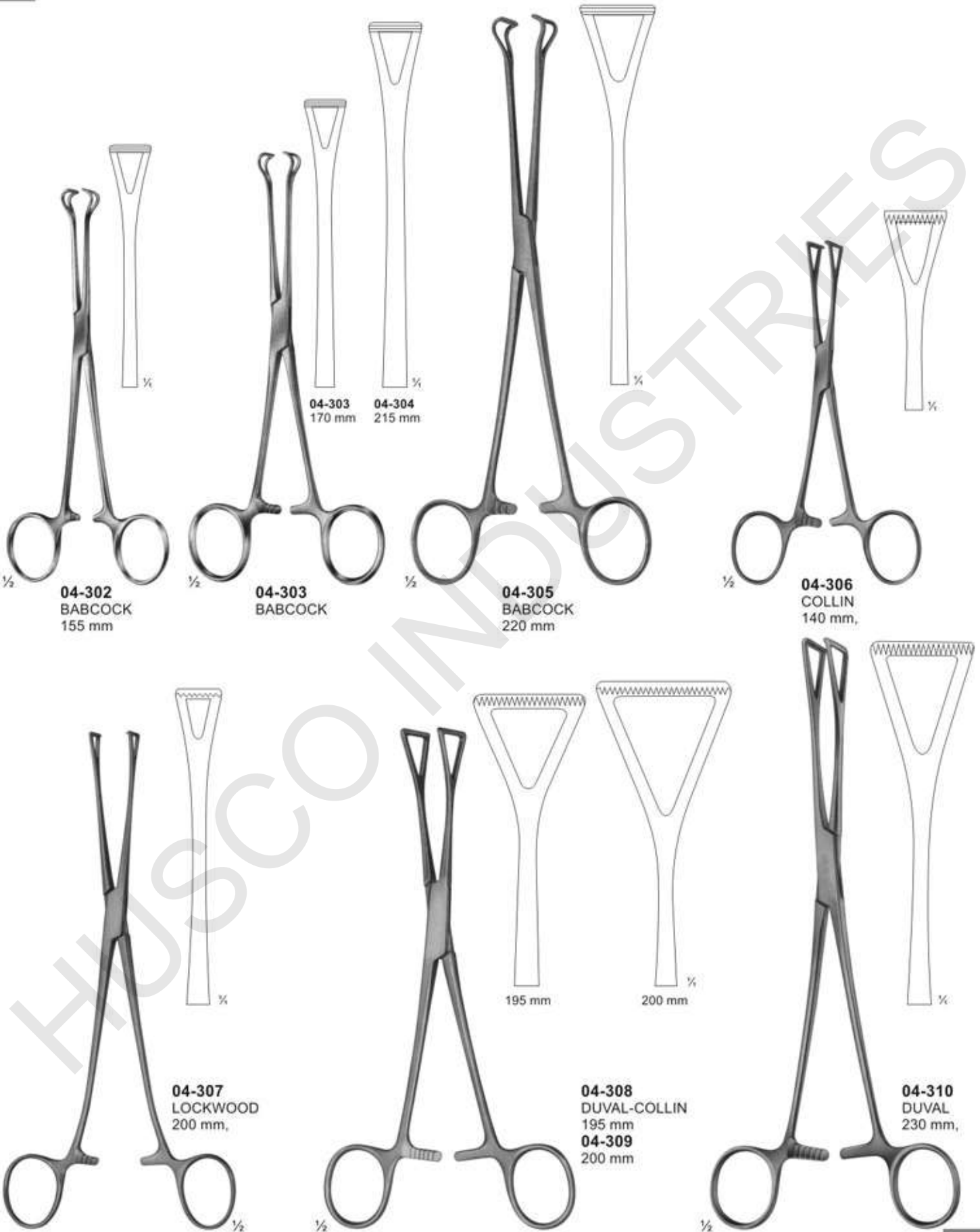

## Artery Traction - and Tissue Grasping Forceps

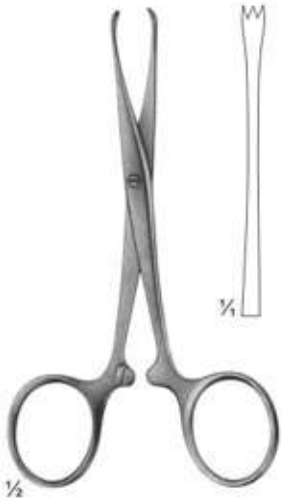

**04-311**  
**CHAPUT**  
 2 x 3 teeth  
 125 mm

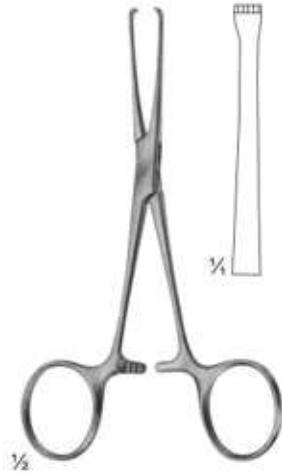

**04-312**  
**BABY-ALLIS**  
 4 x 5 teeth  
 130 mm



**04-313**  
**BOYS-ALLIS**  
 5 x 6 teeth sharp  
 155 mm

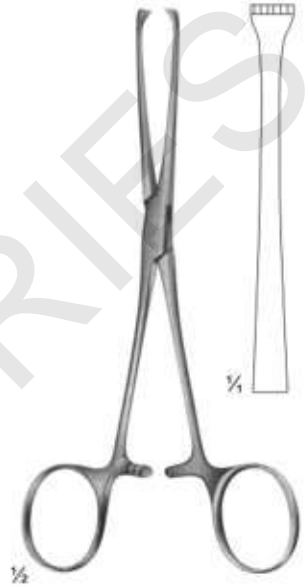

**04-314**  
**ALLIS**  
 5 x 6 teeth  
 155 mm

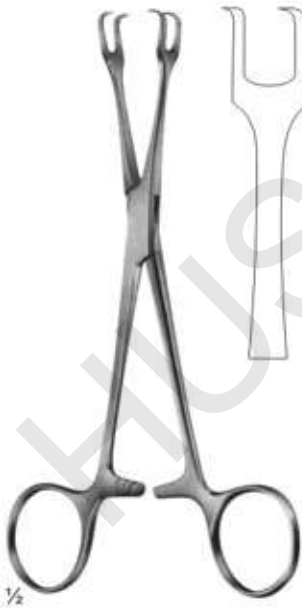

**04-315**  
**LAHEY**  
 155 mm



**04-316**  
**LAHEY**  
 155 mm

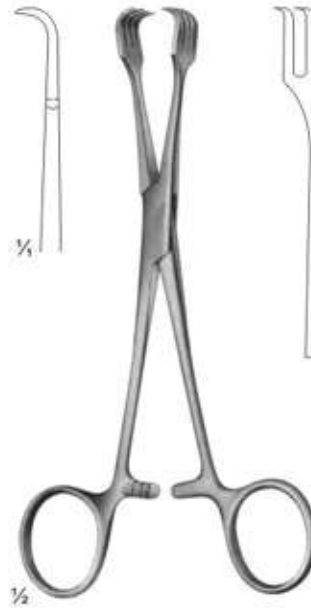

**04-317**  
**BRAUN**  
 155 mm

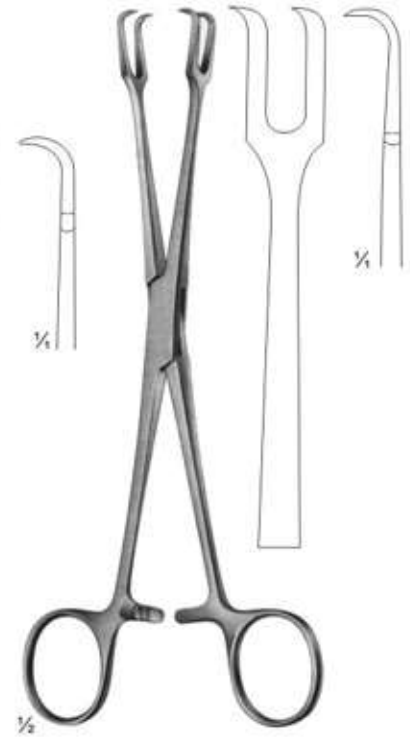

**04-318**  
**MUSEUX**  
 200 mm

**Towel Clamps**

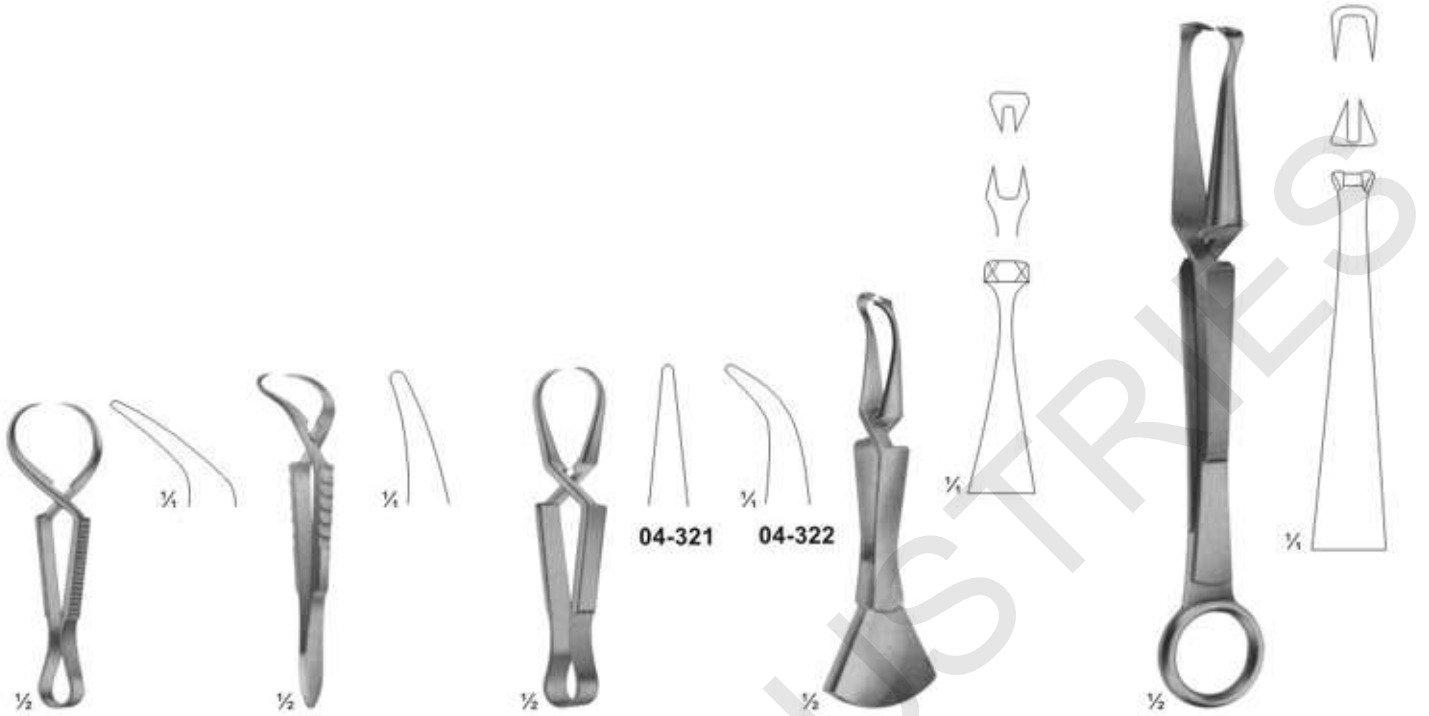

**04-319**  
JONES  
85 mm

**04-320**  
ENGL. MOD.  
85 mm

**04-321 - 04-322**  
SCHAEDEL  
85 mm

**04-323**  
DOYEN  
110 mm

**04-324**  
DOYEN  
180 mm

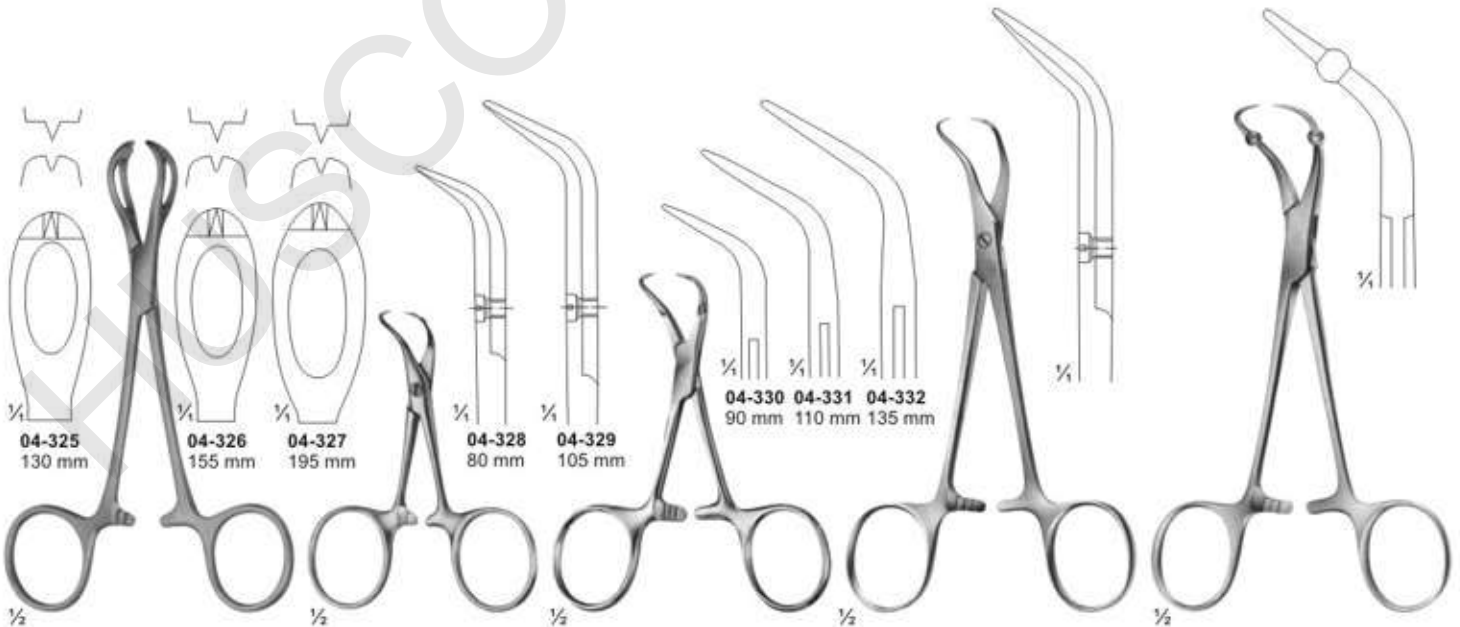

**04-325**  
130 mm

**04-326**  
155 mm

**04-327**  
195 mm

**04-328**  
80 mm

**04-329**  
105 mm

**04-330 04-331 04-332**  
90 mm 110 mm 135 mm

**04-325 - 04-327**  
LANE

**04-328 - 04-329**  
BACKHAUS







**04-330 - 04-332**  
BACKHAUS

**04-333**  
BACKHAUS-KOCHER  
135 mm











**04-334**  
ROEDER  
135 mm

# Muller Vessel Clips and Bulldog Clamps











## Closing force

|   |   |   |   |   |   |   |
|---|---|---|---|---|---|---|
|  |  |  |  |  |  |  |
| 04-335<br>straight  | 04-336<br>curved  | 04-337<br>curved tips   | 04-338<br>angled shaped   | 04-339<br>MULLER<br>knee-bent   | 04-340<br>Muller<br>Ligature Forceps  | Jaw, cross<br>serrated  |
| 80g<br>50g  | 80g<br>50g  | 80g<br>50g  | 80g<br>50g  | 80g<br>50g  | 80g<br>50g  |   |

  

|   |   |  |  |  |  |   |  |  |   |  |   |
|---|---|--|--|--|--|---|--|--|---|--|---|
|  |  |  |  |  |  |  |  |  |  |  |  |
| 04-341<br>35 mm   | 04-342<br>35 mm   | 04-343<br>45 mm  | 04-344<br>45 mm  | 04-345<br>04-346<br>38 mm<br>48 mm   | 04-347<br>04-348<br>38 mm<br>48 mm   | 04-349<br>58 mm   | 04-350<br>58 mm  | 04-351 - 04-357<br>91 mm   | 04-358<br>DE BAKEY-<br>HESS<br>20 mm  |  |   |

|   |   |   |   |   |   |  |   |   |   |   |                    |                     |                              |                    |                     |                              |                    |                     |
|---|---|---|---|---|---|--|---|---|---|---|--------------------|---------------------|------------------------------|--------------------|---------------------|------------------------------|--------------------|---------------------|
|  |  |  |  |  |  |  |  |  |  |  |                    |                     |                              |                    |                     |                              |                    |                     |
| 04-359<br>length<br>50 mm<br>jaws<br>27 mm  | 04-360<br>length<br>48 mm<br>jaws<br>27 mm  | 04-361<br>GLOVER<br>length<br>57 mm<br>jaws 35 mm                                   | 04-362<br>DE BAKEY<br>length 73 mm<br>jaws 38 mm                                    | 04-363<br>DE BAKEY<br>length 99 mm<br>jaws 63 mm                                    | 04-364<br>DE BAKEY<br>length 95 mm<br>jaws 54 mm                                    | 04-365<br>L. 80 mm   | 04-366<br>L. 90 mm  | 04-367<br>L. 105 mm   | 04-369<br>L. 78 mm  | 04-370<br>L. 86 mm  | 04-371<br>L. 97 mm | 04-372<br>L. 114 mm | 04-373<br>GLOVER<br>L. 68 mm | 04-374<br>L. 96 mm | 04-375<br>L. 117 mm | 04-376<br>GLOVER<br>L. 65 mm | 04-377<br>L. 91 mm | 04-378<br>L. 110 mm |

## Delicate Haemostatic Forceps

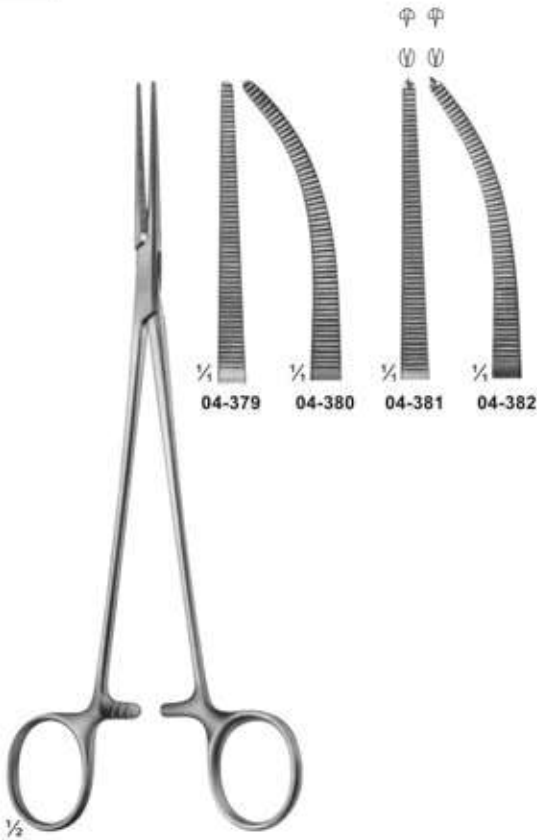

**04-379 - 04-382**  
HALSTED-MOSQUITO  
200 mm



**04-383 - 04-387**  
HEISS  
200 mm



**04-388 - 04-389**  
HALSTED  
215 mm



**04-390 - 04-393**  
BENGOLEA  
245 mm



**04-394**  
CRAFOORD  
245 mm

# Delicate Haemostatic Forceps



**04-395**  
CARREL  
85 mm



**04-396 - 04-399**  
BABY-MOSQUITO  
(HARTMANN)  
100 mm



**04-400 - 04-403**  
MICRO-HALSTED  
125 mm

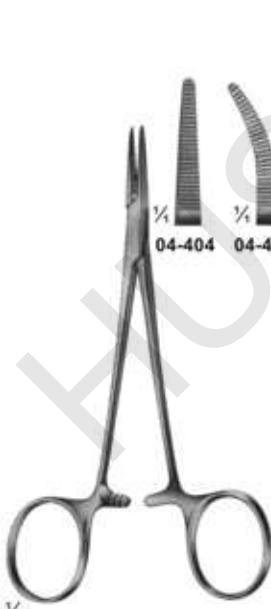

**04-404 - 04-407**  
HALSTED-MOSQUITO  
125 mm

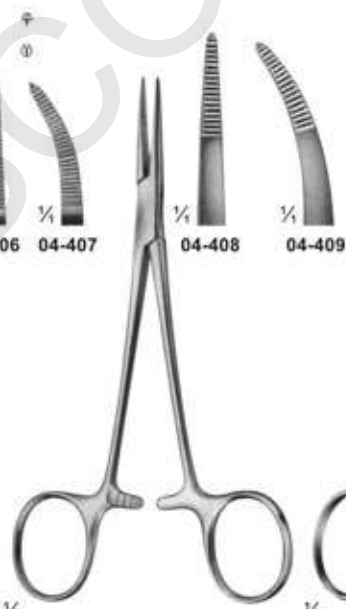

**04-408 - 04-409**  
PROVIDENCE-HOSPITAL  
140 mm



**04-410 - 04-411**  
KELLY  
140 mm

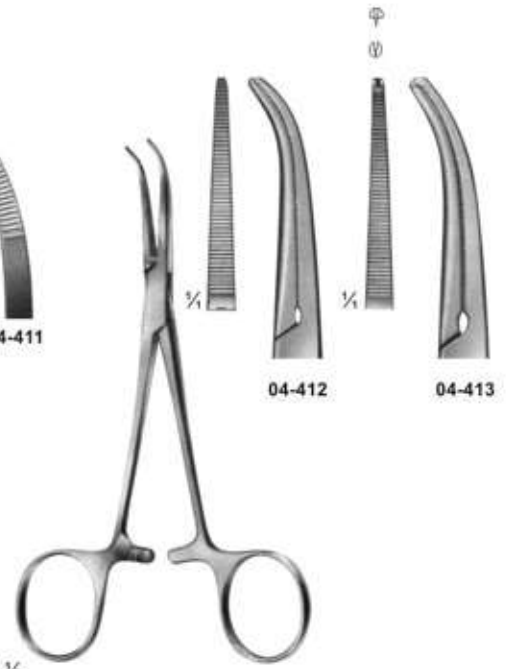

**04-412 - 04-413**  
DANDY  
Curved sideways  
140 mm

## Delicate Haemostatic Forceps

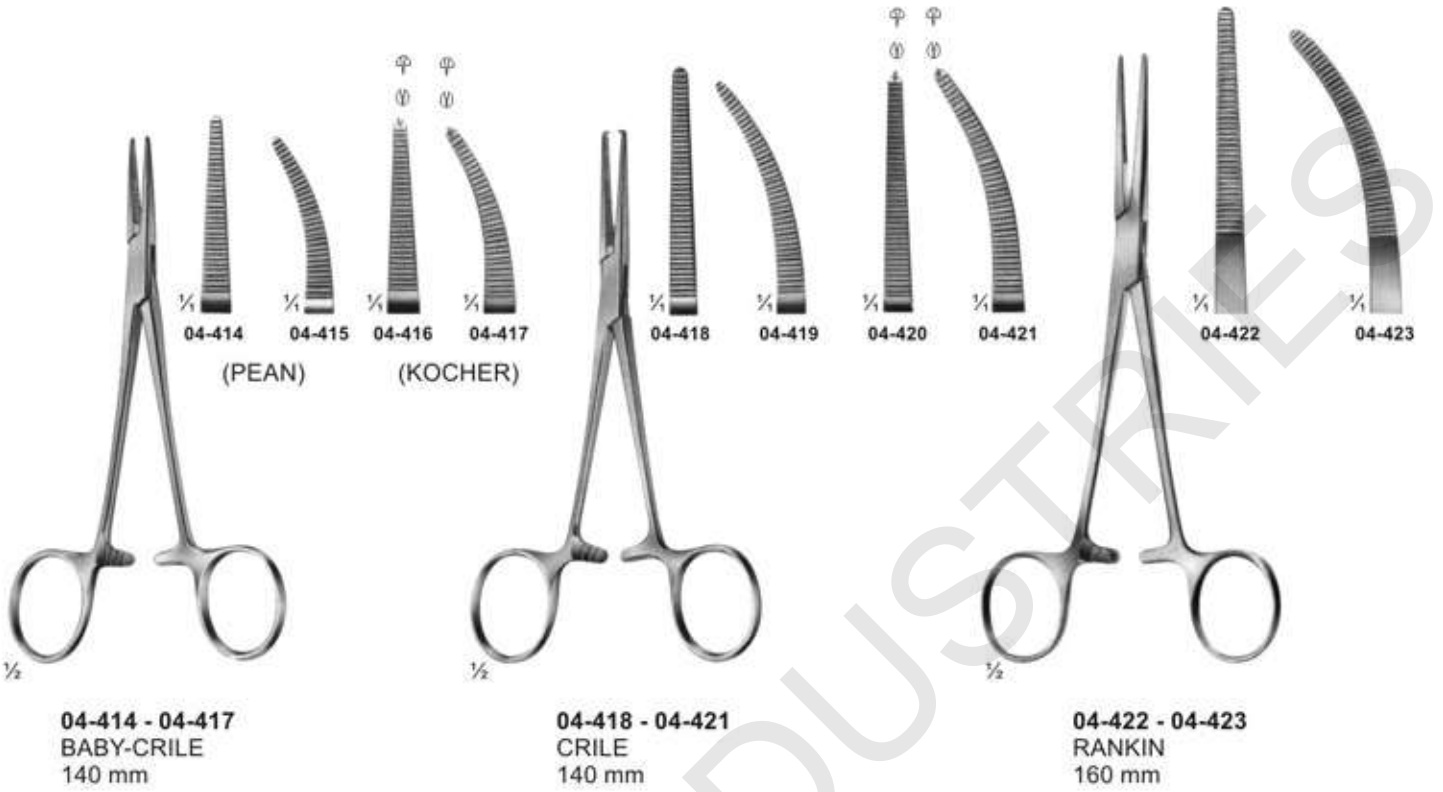

# Haemostatic Forceps



**04-434 - 04-437**  
PEAN  
Slender type

**04-438 - 04-445**  
SPENCER-WELLS  
Slender type

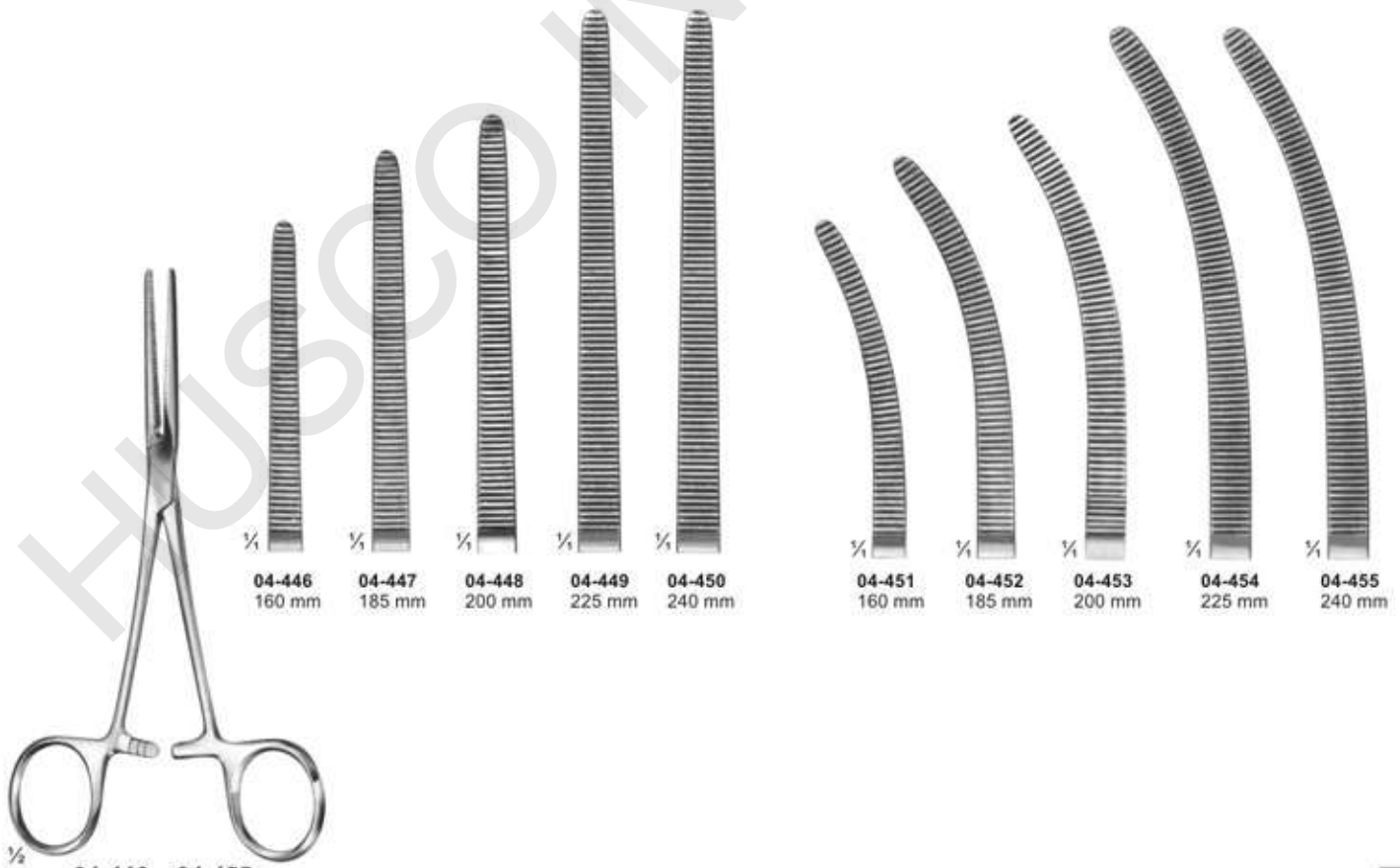

**04-446 - 04-455**  
ROCHESTER-PEAN



# Haemostatic Forceps



**04-456 - 04-461**  
PEAN

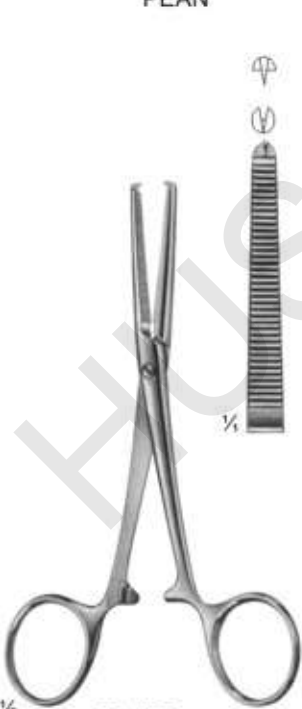
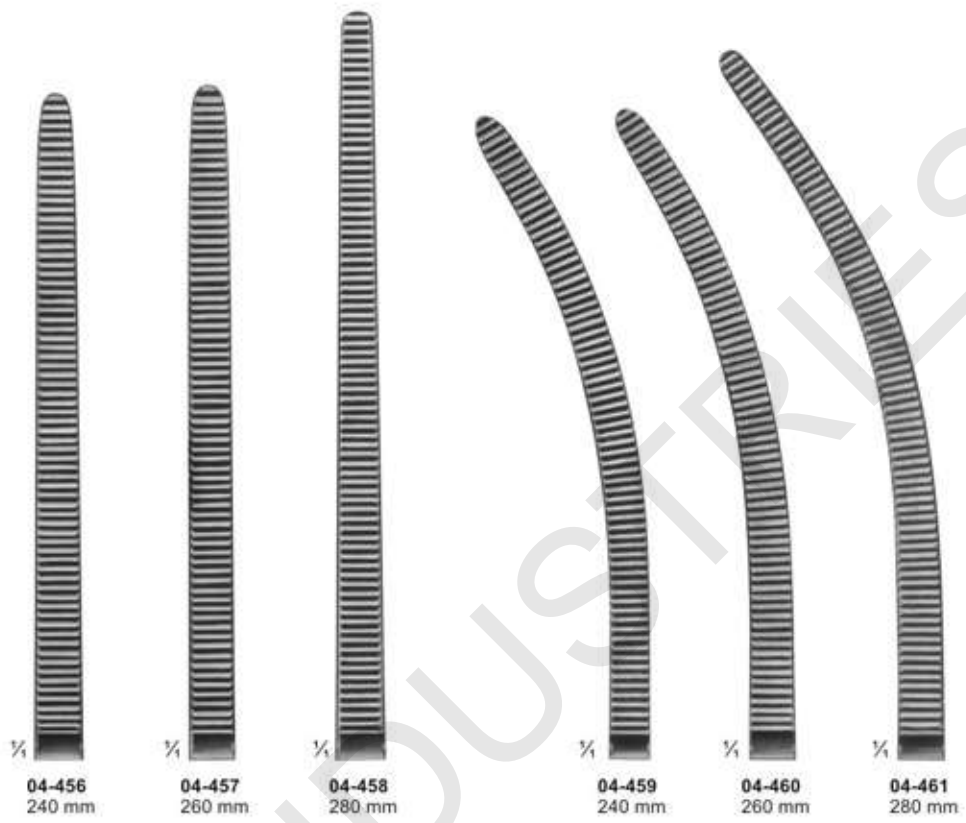

**04-462**  
KOCHER  
Strong Pattern  
145 mm

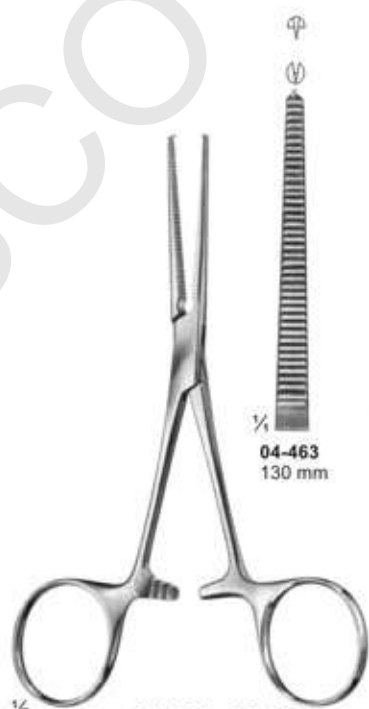

**04-463 - 04-465**  
KOCHER



**04-466 - 04-467**  
ROCHESTER-OGHSNER  
140 mm

# Haemostatic Forceps

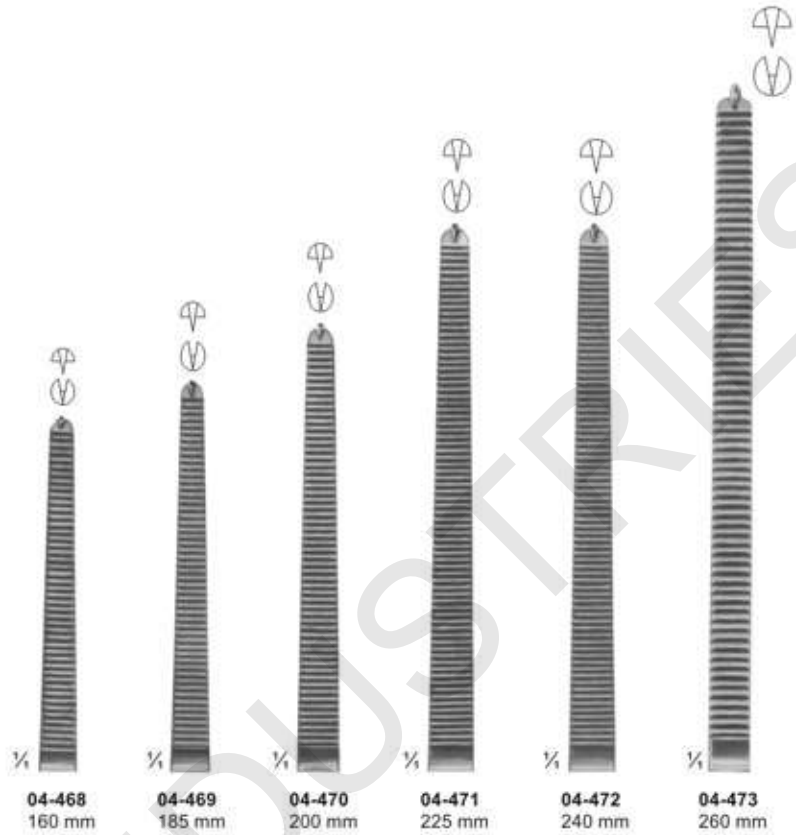

**04-468 - 04-479**  
KOCHER-OCHSNER

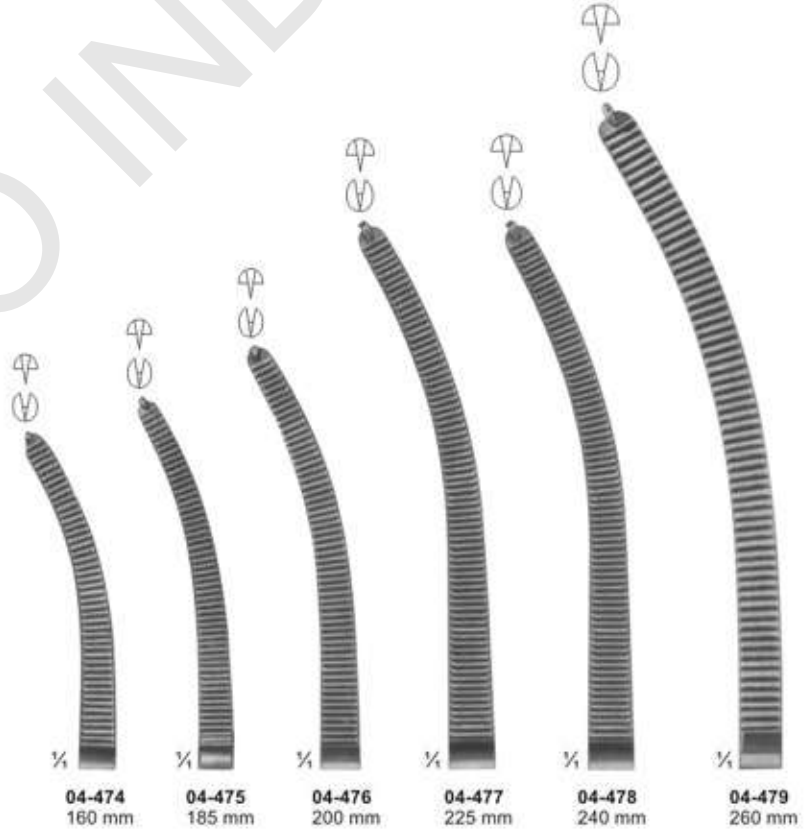

## Haemostatic Forceps

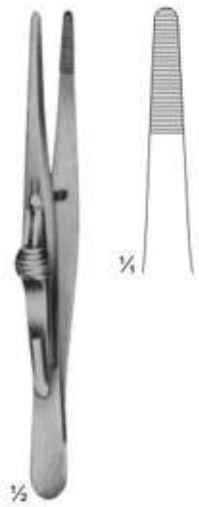

**04-480**  
FRICKE  
Artery forceps  
130 mm



**04-481**  
KRONLEIN  
130 mm

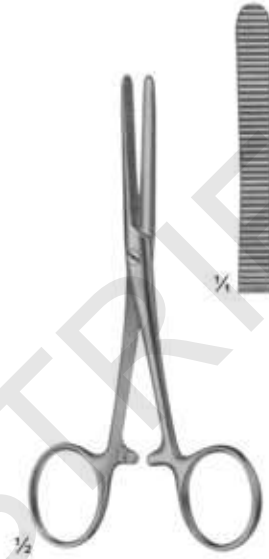

**04-482**  
PEAN  
125 mm



**04-483**  
125 mm



**04-484**  
140 mm

**04-483 - 04-484**  
PEAN



**04-485**  
PEAN  
125 mm

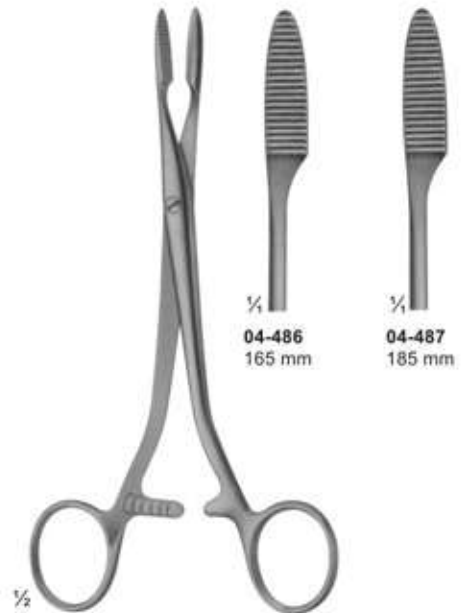

**04-486**  
165 mm

**04-487**  
185 mm

**04-486 - 04-487**  
PEAN

**Haemostatic Forceps, Special Pattern, Tonsil Forceps**

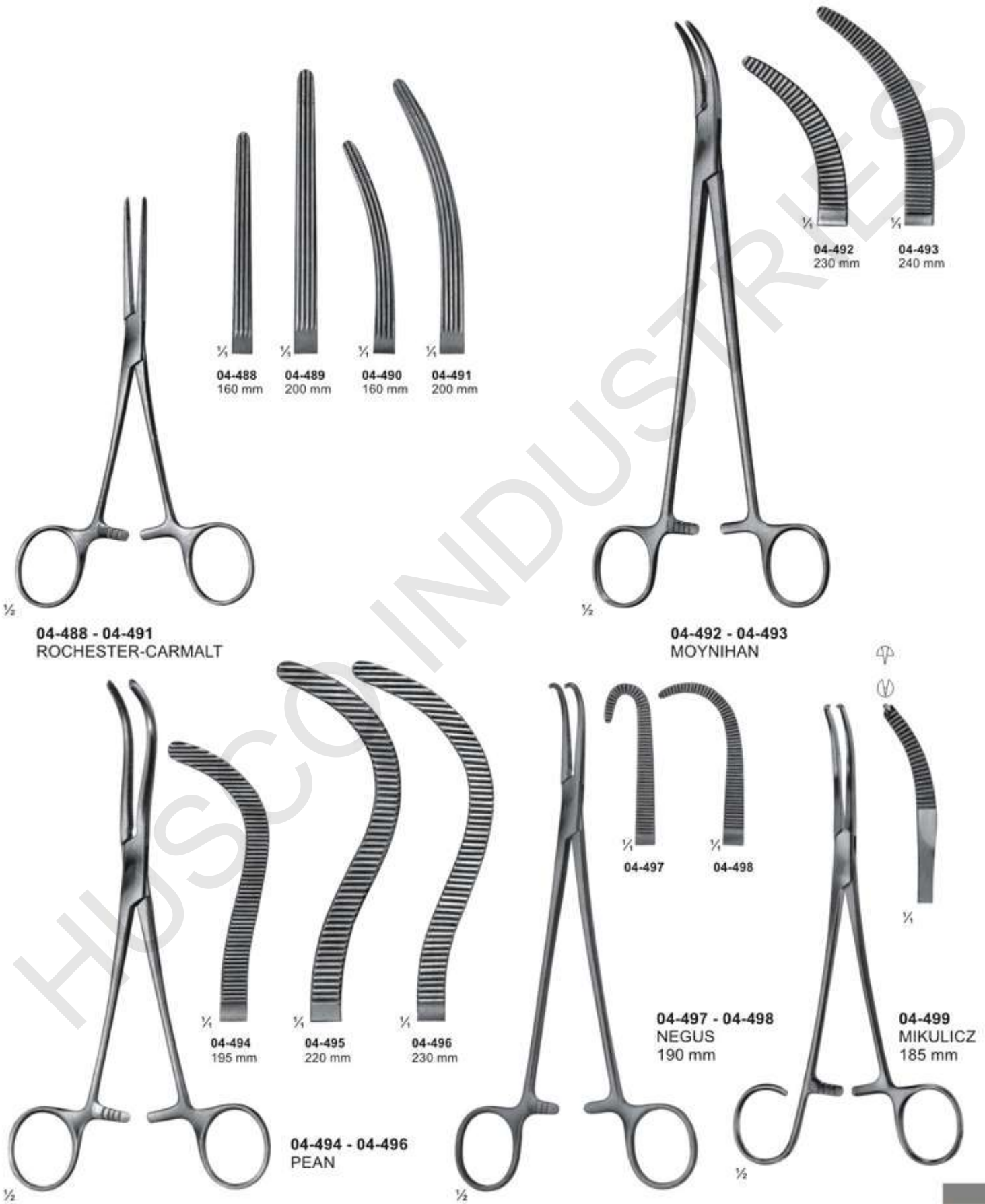

## Dissecting- and Ligature Forceps



**04-500**  
MIXTER-O'SHAUGNESSY  
190 mm

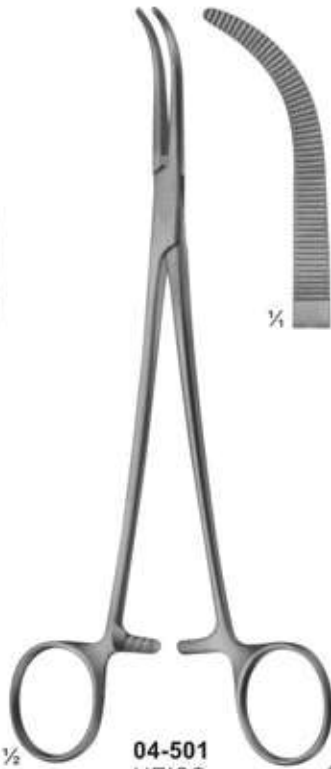

**04-501**  
HEISS  
195 mm



**04-502 - 04-506**  
RUMEL  
240 mm

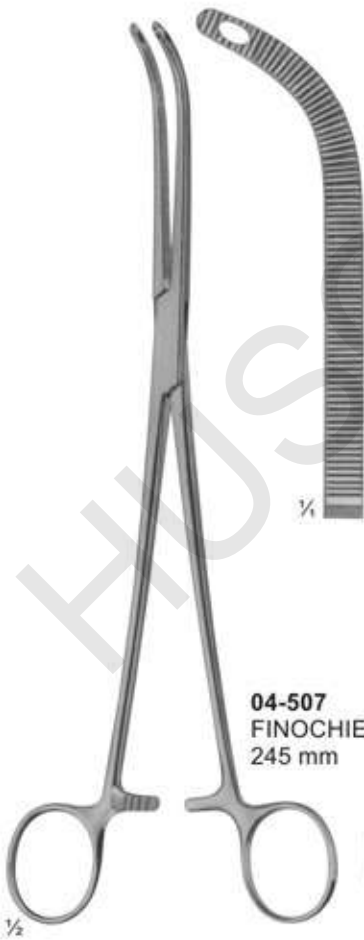
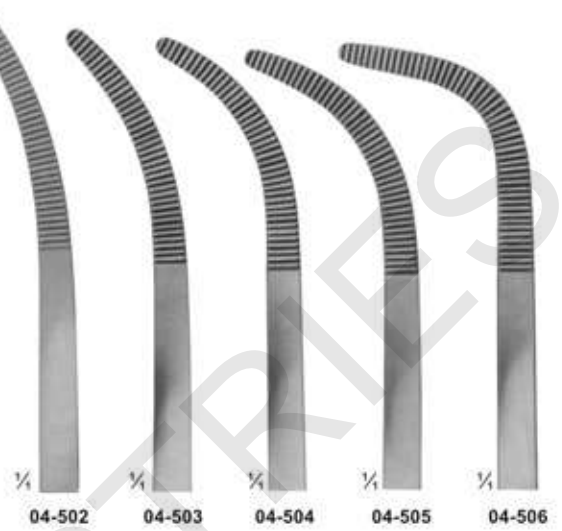

**04-507**  
FINOCHIETTO  
245 mm



**04-508**  
MIXTER  
230 mm



**04-509**  
LAWRENCE  
270 mm

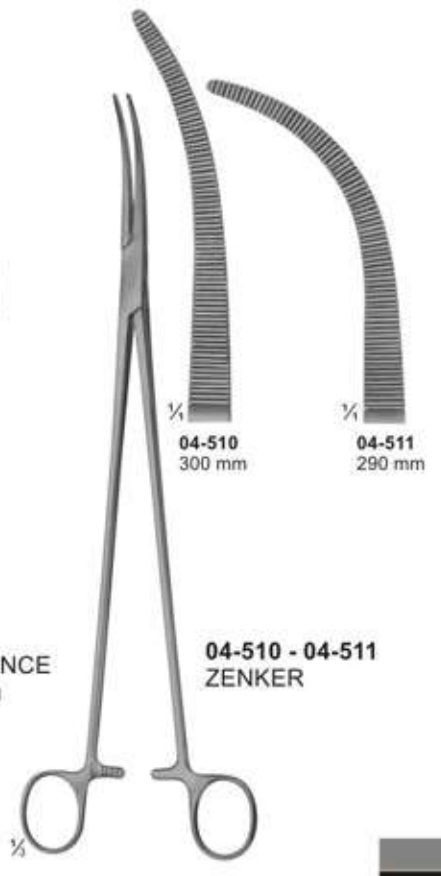

**04-510 - 04-511**  
ZENKER

# Hysterectomy Forceps, Vaginal Clamps and Compression Forceps



**04-512**  
**WERTHEIM**  
 Hysterectomy forceps  
 255 mm



**04-513**  
**WERTHEIM**  
 Parametrium clamp  
 260 mm



**04-514 - 04-516**  
**DICK**



**04-514** 255 mm  
**04-515** 265 mm  
**04-516** 275 mm

**Hysterectomy Forceps, Vaginal Clamps  
and Compression Forceps**

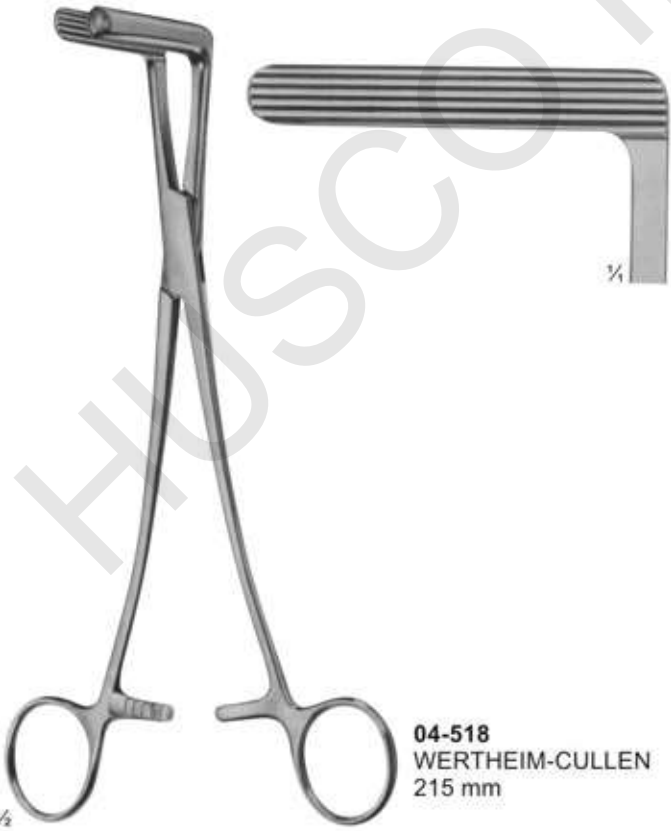
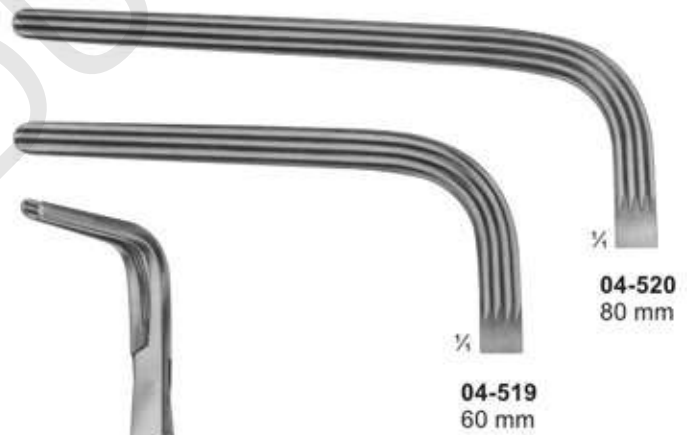

## Needle Holders for micro surgery



**05-101**  
ROHRSCHEIDER  
with copper inserts  
100 mm



**05-102**  
KALT  
with catch  
135 mm



**05-103**  
ARRUGA  
with catch  
135 mm



**05-104 - 105**  
CASTROVIEJO  
with catch  
145 mm



**05-106 - 107**  
without Catch  
160 mm



**05-108 - 109**  
without catch  
185 mm



**05-109**



**05-110 - 111**  
JACOBSON  
without catch  
185 mm

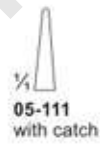

**05-110**  
without catch

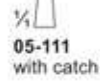

**05-111**  
with catch



**05-112**  
without catch  
195 mm



**05-113 - 114**  
YASARGIL  
with catch  
200 mm

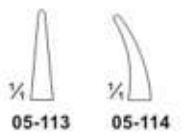

**05-113**

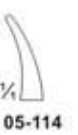

**05-114**



## Needle Holders



# Needle Holders



**05-127 - 128**  
HEGAR-OLSEN  
255 mm

**05-127**  
140 mm

**05-128**  
185 mm



**05-129**  
GILLIES  
150 mm

**05-130**  
GILLIES  
160 mm

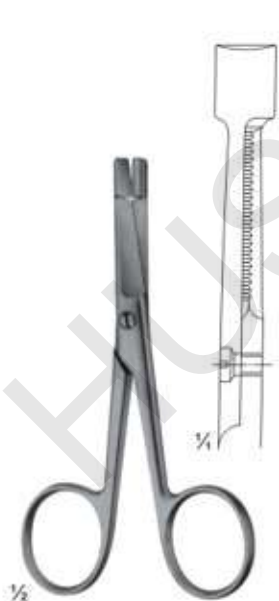

**05-131**  
EISELSBERG  
115 mm

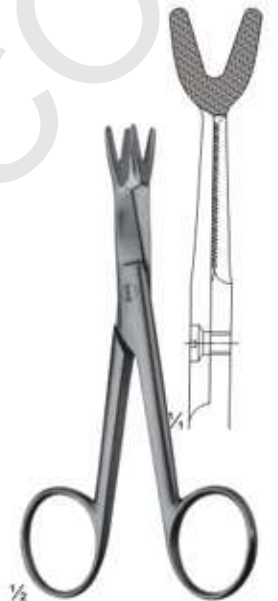

**05-132**  
SCHOEMAKER-LOTH  
125 mm



**05-133**  
CRILE  
150 mm

**05-134**  
TOENNIS  
Elastic pattern for dura-or  
intestinal suture. 180 mm

## Needle Holders

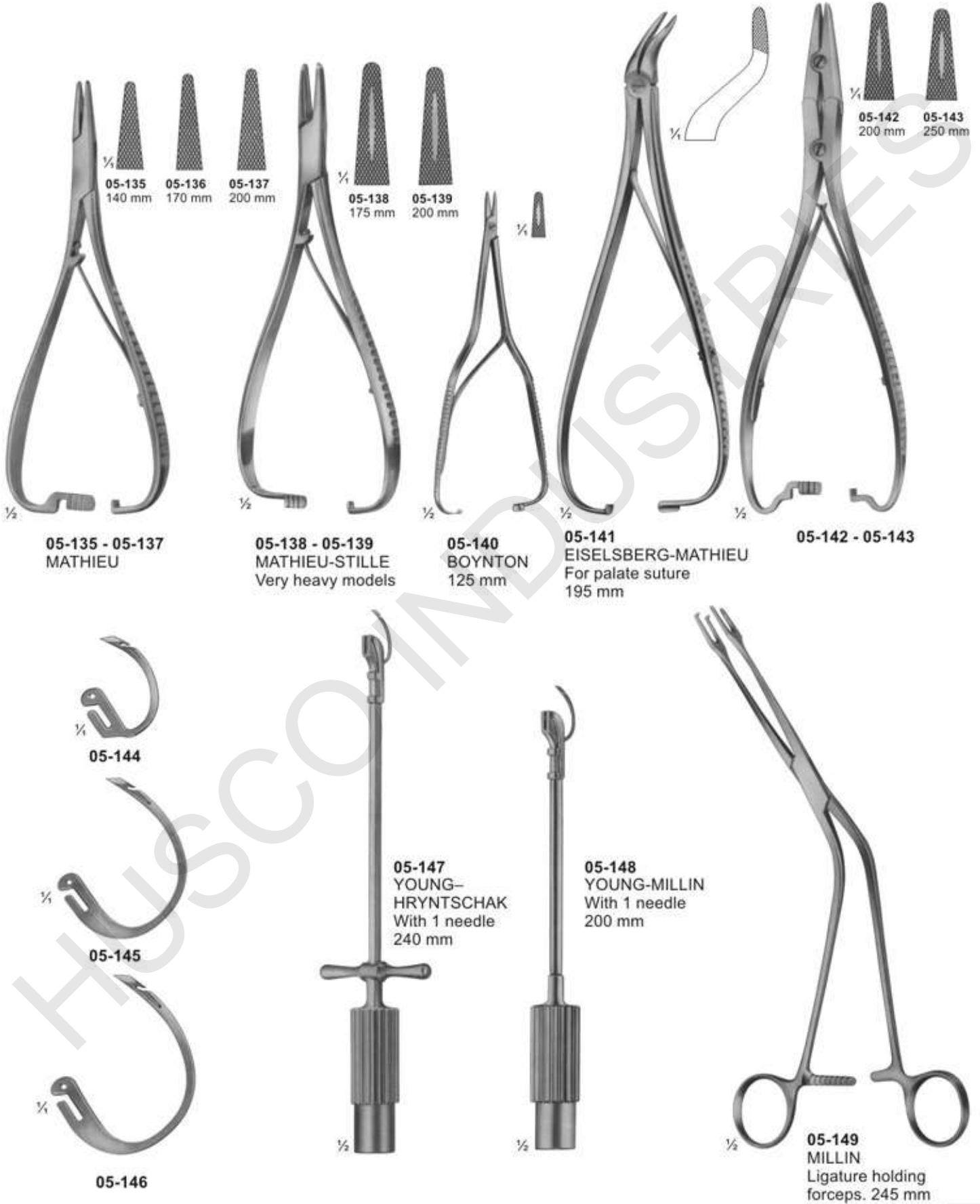

## Suture Instruments - Reverdin Needles



# Probes



**05-162** 130 mm  
**05-163** 145 mm  
**05-164** 160 mm  
 Directors



**05-165**  
**DOYEN**  
 145 mm  
 Directors



**05-166**  
**NELATON**  
 160 mm  
 Directors



**05-167**  
 Director with tip  
 Diam. Of tip 3,3 mm  
 140 mm

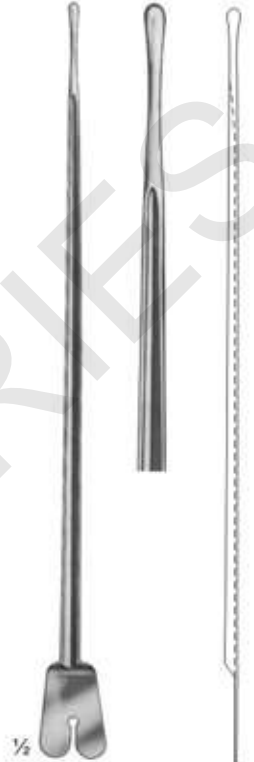

**05-168**  
**BRODIE**  
 Director with tip,  
 Diam. Of tip 3,5 mm  
 200 mm

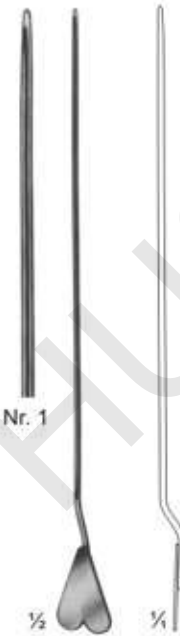

**05-169**  
**LOCKHART-MUMMERY**  
 165 mm



**05-170**  
**LOCKHART-MUMMERY**  
 165 mm

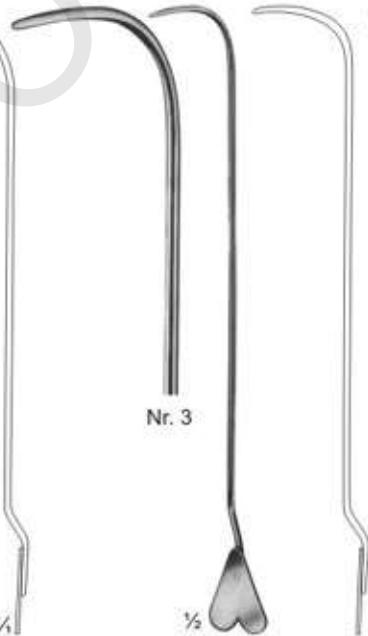

**05-171**  
**LOCKHART-MUMMERY**  
 165 mm

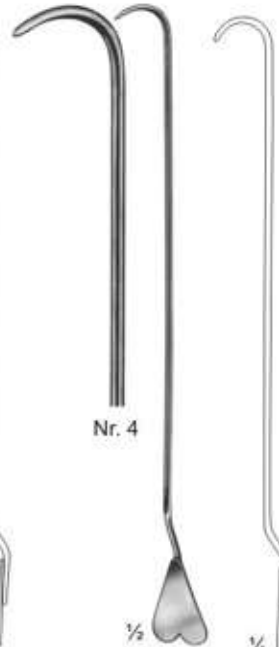

**05-172**  
**LOCKHART-MUMMERY**  
 165 mm



**05-173**  
 Director with wire  
 loop, malleable  
 190 mm

# Probes



05-174  
2,5 mm  
05-175  
2,5 mm  
05-176  
3,0 mm

05-174 145 mm  
05-175 160 mm  
05-176 200 mm  
Probes with eye



1,5 mm

05-177  
Myrtle leaf probe  
145 mm



2,0 mm

05-178 130 mm  
05-179 145 mm  
05-180 160 mm  
05-181 180 mm  
05-182 200 mm



05-183  
Probes



05-184  $\frac{1}{2}$   
Double ended probe,  
malleable, diam. of tips  
3 mm with hole  
190 mm



05-185  
Double ended probes,  
tin, malleable,  
diam. of tips  
3,5 mm with hole  
250 mm, 300 mm



05-186  $\frac{1}{4}$   
Double ended probes,  
tin, malleable,  
diam. of tips 4 mm  
400 mm



$\frac{1}{2}$   $\varnothing$  tip  
05-187 1,5 mm  
05-188 2,0 mm  
05-189 2,5 mm  
300 mm

## Suturing Instrument Set, Pocket Instrument Set



### 05-190

Suturing instruments set, in metal case consisting of: Scissors, curved, sharp/sharp, 115mm  
25 MICHEL clip, 16 x 3mm  
1 Delicate tissue forceps, 130mm  
1 Scalpel, bellied  
1 MATHIEU needle holder, 140mm  
1 Perforated metal case, stainless containing:  
1 Suture needle  
1 item 1 item



### 05-191

Pocket instrument set, in metal case consisting of:

#### Bottom tray

1 MATHIEU needle holder, 140mm  
1 MICHEL clip forceps, combined  
1 Myrtle leaf probe, 130mm  
1 Sharp double curette  
1 Skin hook  
1 Detachable scalpel handle, no.4  
1 Perforated metal case, containing  
6 Scalpel blades  
1 Perforated metal case, stainless, containing  
1 Suture needle  
1 item  
1 item

#### Top tray

1 Tissue forceps, 130mm  
1 KOCHER haemostatic forceps, 130mm  
1 Straight surgical scissors, 130mm  
1 Dissecting forceps, 130mm  
1 FEILCHENFELD splinter forceps, 115mm  
25 MICHEL clip, 16 x 3mm  
1 Flacon of suture skin, sterile in alcohol



### 05-192

Pocket instrument set, in metal case consisting of:

#### Bottom tray

1 MAYO-HÉGER needle holder, 150mm  
1 MICHEL clip forceps, combined  
1 Myrtle leaf probe, 130mm  
1 Sharp double curette  
1 Skin hook  
1 Detachable scalpel handle, no. 4  
1 Perforated metal case, consisting  
6 Scalpel blades  
1 Perforated metal case, stainless, consisting:  
1 Suture needle  
1 item, & 1 item

#### Top tray

1 Tissue forceps, 130mm  
1 CRILE haemostatic forceps, 140mm  
1 Straight surgical scissors, 130mm  
1 Dissecting forceps, 130mm  
1 FEILCHENFELD splinter forceps, 115mm  
25 MICHEL clip, 16 x 3mm  
1 Flacon of suture silk, sterile in alcohol



## Fine Wound Retractors (Dura- and Skin Retractors)

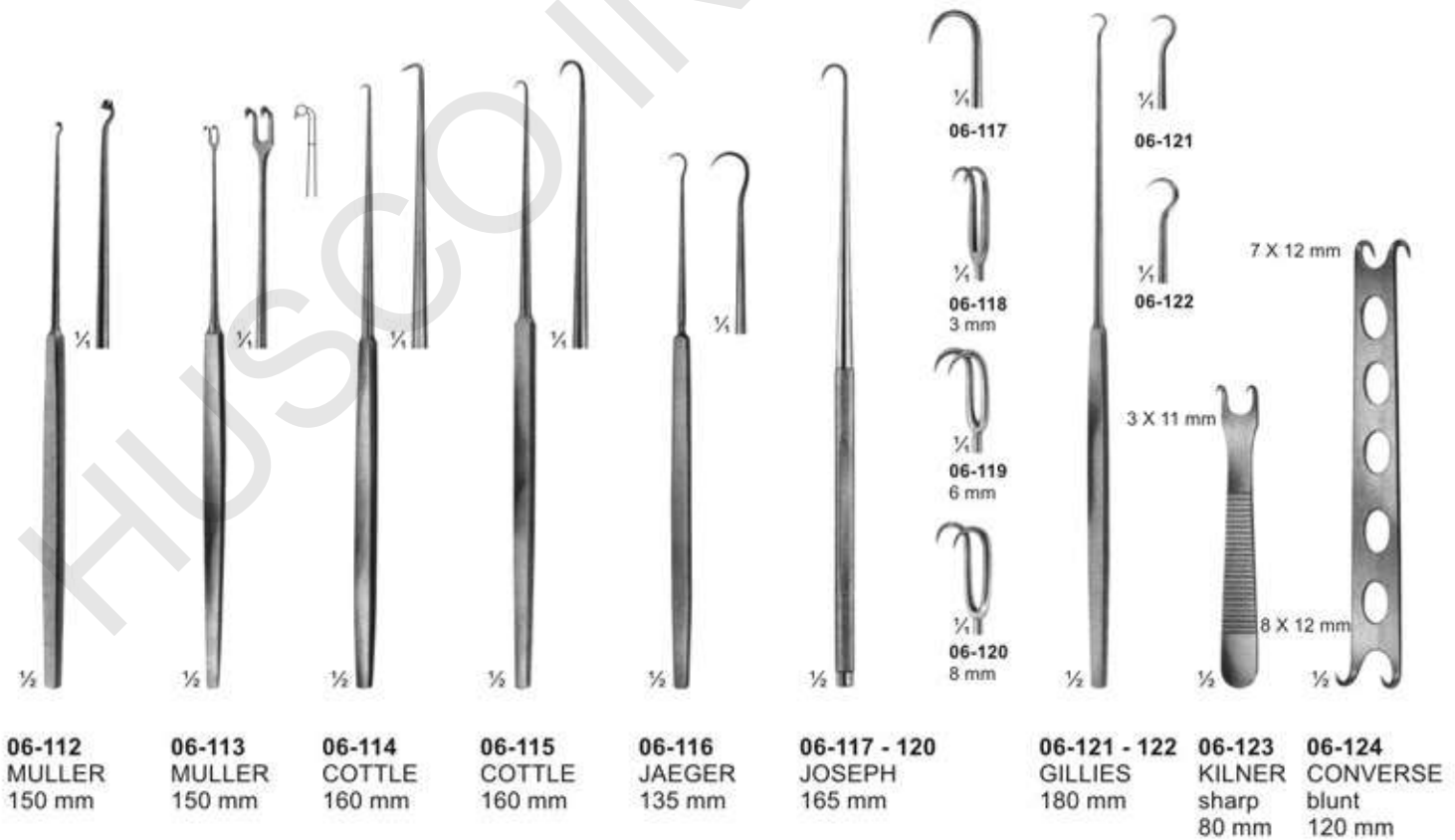
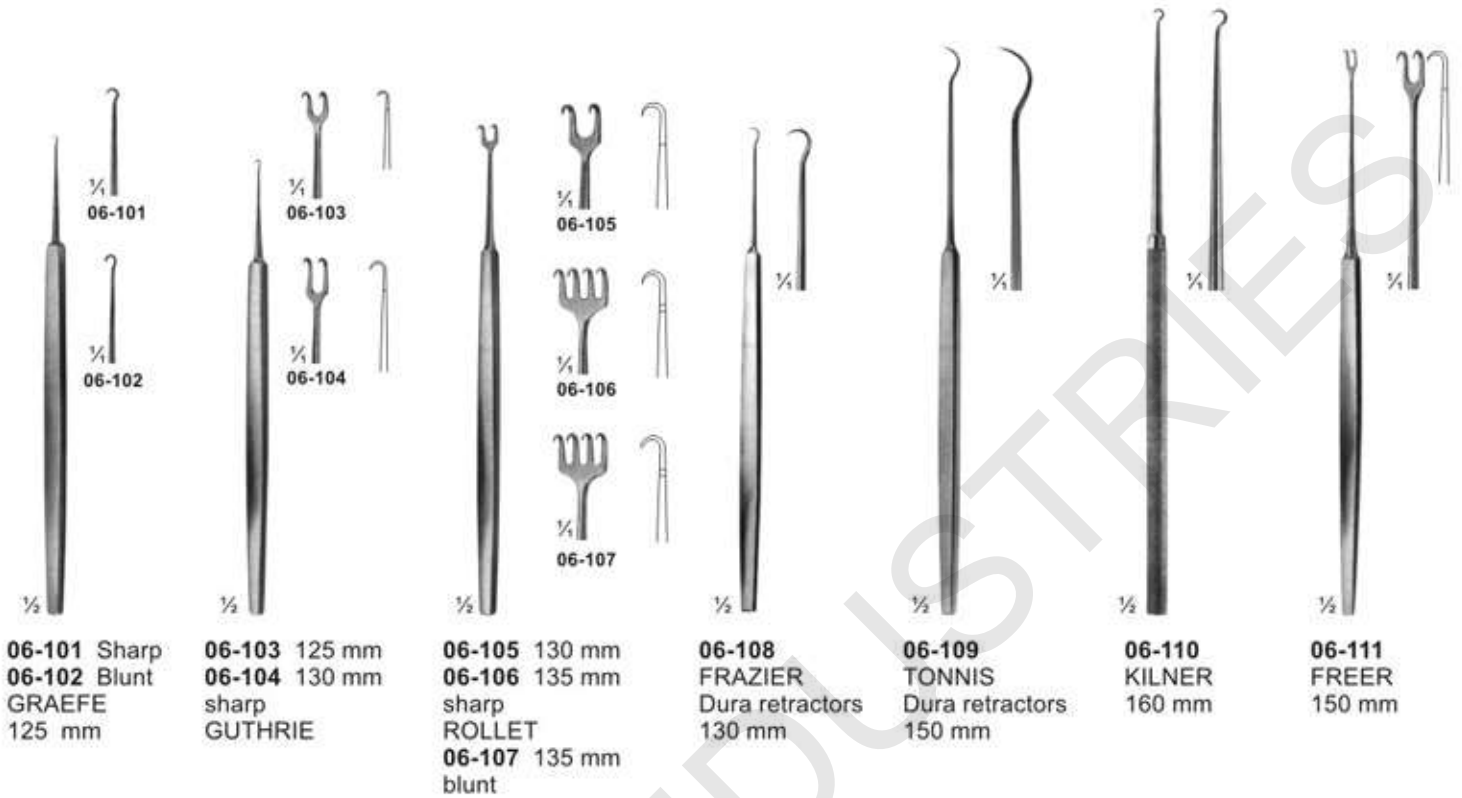



## Retractors With treangle handle

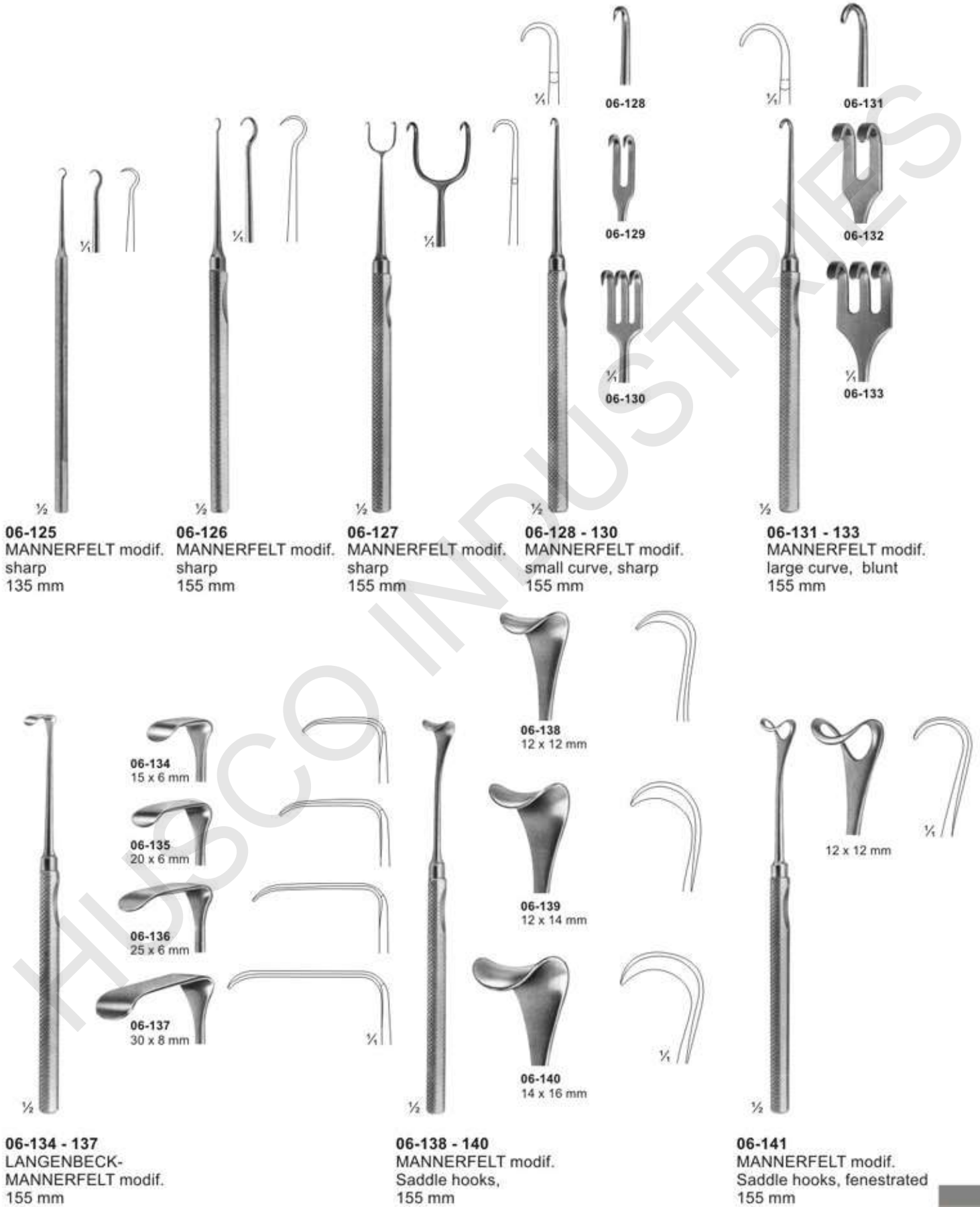

# Retractors



¼  
6 x 12 mm

¼  
**06-142**  
MASING  
140 mm



¼  
10 x 12 mm

¼  
**06-143**  
COTTLE  
140 mm



**06-144**  
9 x 9 mm

**06-145**  
9 x 12 mm



¼  
**06-146**  
11 x 14 mm



**06-147**  
12 x 16 mm



¼  
**06-148**  
13 x 18 mm



¼  
**06-149**  
13 x 13 mm



¼  
10 x 10 mm



¼  
**06-150**  
12 x 16 mm

½  
**06-149 - 150**  
KONIG  
180 mm

½  
**06-151**  
CUSHING-KOCHER  
175 mm



¼  
**06-152**  
20 x 12 mm



¼  
**06-153**  
20 x 15 mm

½  
**06-152 - 153**  
KOCHER  
205 mm



¼  
13 x 6 mm

½  
**06-154**  
SCHOENBORN  
200 mm



¼  
**06-155**  
10 x 13 mm

½  
**06-155 - 156**  
CUSHING  
205 mm



¼  
**06-156**  
14 x 18 mm



20 x 15 mm

20 x 19 mm

½  
**06-157**  
205 mm



¼  
**06-158**  
11 x 14 mm



¼  
**06-159**  
13 x 18 mm

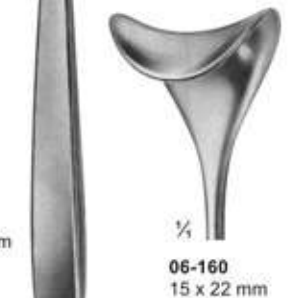

¼  
**06-160**  
15 x 22 mm

½  
**06-158 - 160**  
CUSHING  
250 mm

## Retractors



# Retractors

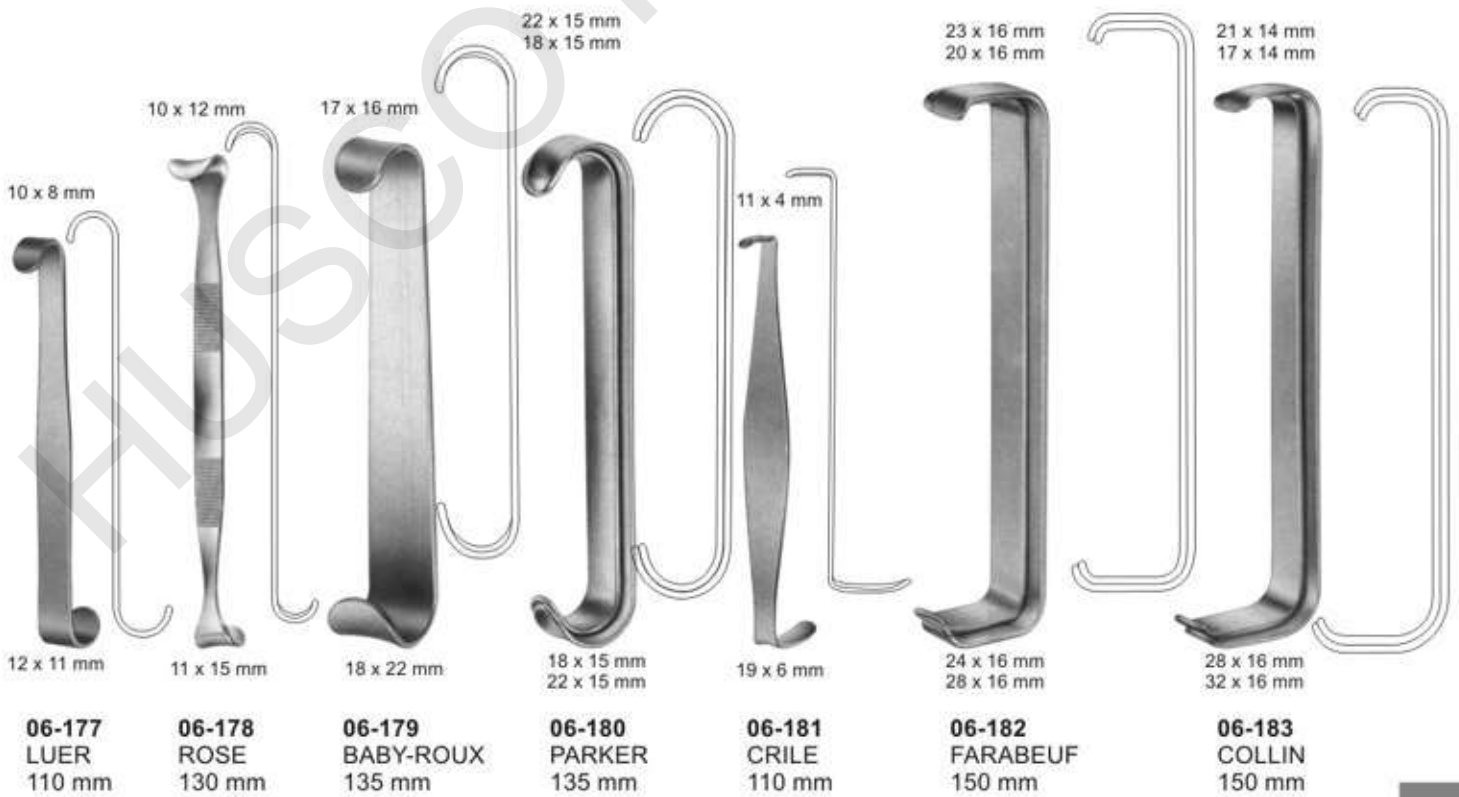

## Bone Retractors and Retractors



**06-184**  
KOCHER  
sharp  
205 mm



**06-185**  
KOCHER  
sharp  
220 mm



**06-186**  
KOCHER  
sharp  
220 mm



**06-187**  
VOLKMANN  
blunt  
220 mm



**06-188**  
VOLKMANN  
sharp  
220 mm



**06-189 - 06-196**  
VOLKMANN  
225 mm



**06-189**  
9 x 8 mm



**06-190**  
9 x 13 mm



**06-191**  
9 x 19 mm



**06-192**  
9 x 29 mm

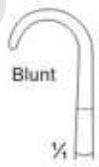

**06-193**  
8,5 x 8 mm



**06-194**  
8,5 x 13 mm



**06-195**  
8,5 x 19 mm



**06-196**  
8,5 x 29 mm

## Retractors



1/2  
**06-197**  
15 x 15 mm  
220 mm



1/2  
**06-198**  
20 x 22 mm  
215 mm



1/2  
**06-199**  
28 x 28 mm  
235 mm



1/2  
**06-200**  
BUCHS  
205 mm



38 x 18 mm



67 x 17 mm



1/2  
**06-201**  
CASPAR  
210 mm



1/2  
**06-202**  
KOCHER  
230 mm

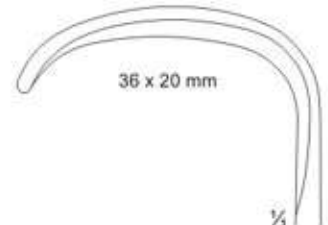

36 x 20 mm

# Retractors, Vario Retractor System



- 06-203-06-209  
BRUNNER  
275 mm
- |        |          |
|--------|----------|
| 06-203 | 80 x 20  |
| 06-204 | 100 x 25 |
| 06-205 | 120 x 25 |
| 06-206 | 130 x 30 |
| 06-207 | 140 x 30 |
| 06-208 | 160 x 30 |
| 06-209 | 180 x 30 |



06-210  
Handle with cold  
light carrier for  
retractor blades.  
280 mm

Handle arrange-  
ment verriable

## Retractors, Lung Spatulas





**Retractors for deep surgery  
(Abdominal Retractors)**

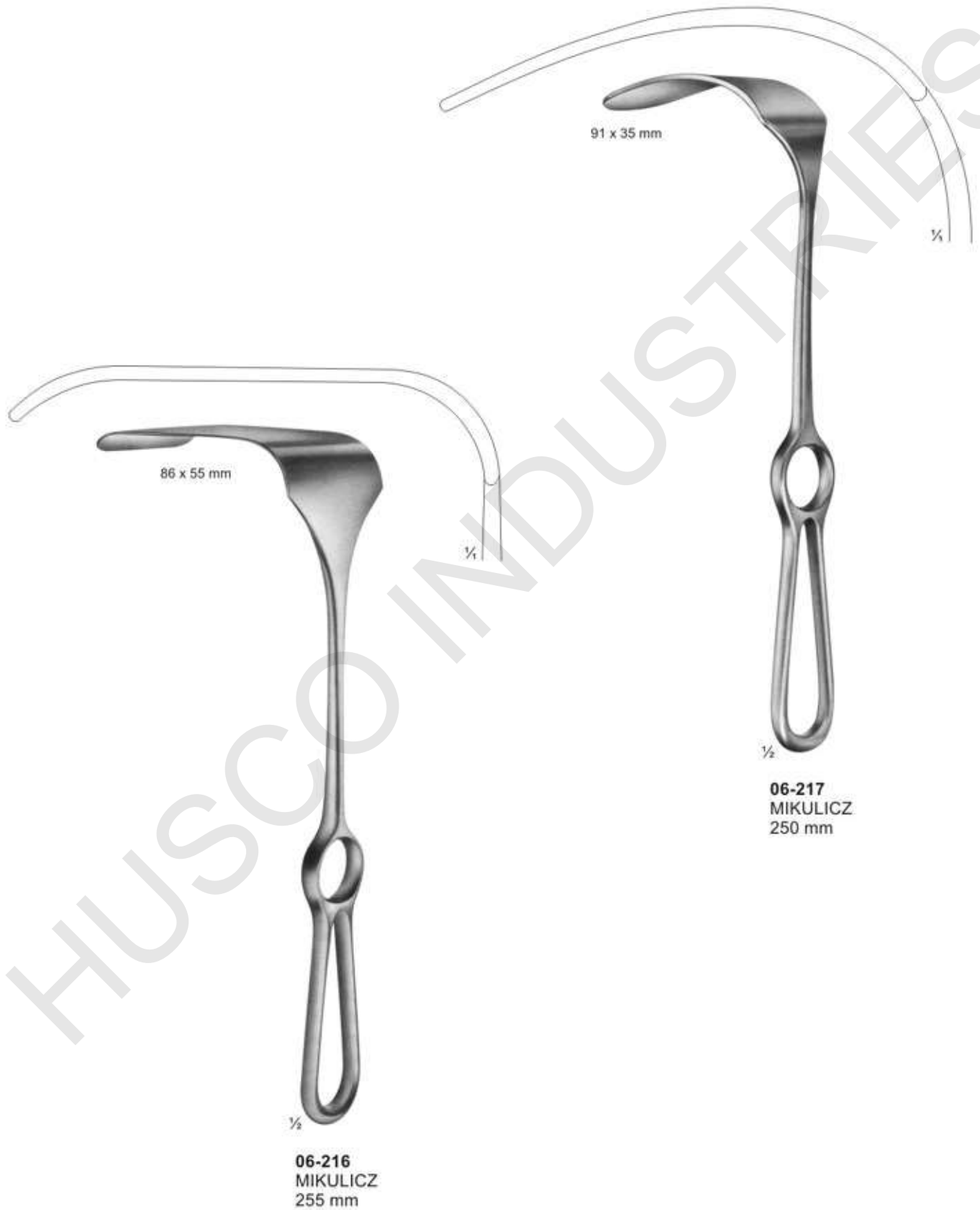

# Retractors, Abdominal Retractors

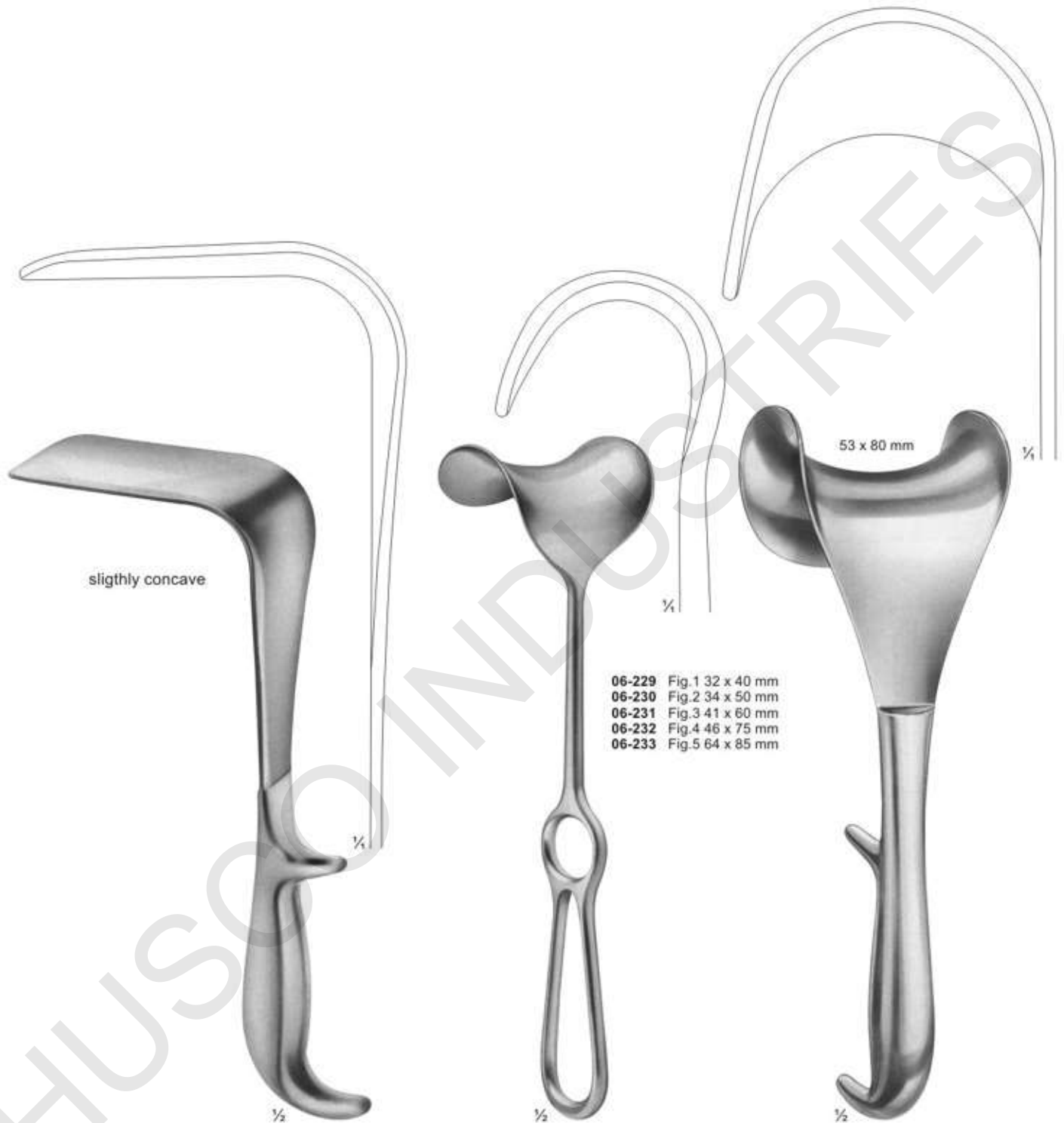

- 06-229 Fig.1 32 x 40 mm
- 06-230 Fig.2 34 x 50 mm
- 06-231 Fig.3 41 x 60 mm
- 06-232 Fig.4 46 x 75 mm
- 06-233 Fig.5 64 x 85 mm

**06-218 - 06-228**  
DOYEN  
240 mm

**06-229 - 06-233**  
FRITSCH  
240 mm

**06-234**  
DOYEN  
250 mm

|                  |                          |
|------------------|--------------------------|
| width of blades  | 35 mm, 45 mm, 60 mm      |
| length of blades |                          |
| 62 mm            | 06-218 , 06-222 , 06-226 |
| 92 mm            | 06-219 , 06-223 , 06-227 |
| 122 mm           | 06-220 , 06-224 , 06-228 |
| 160 mm           | 06-221 , 06-225          |

**Abdominal- and Intestinal Spatulas**  
**Bauch- und Darmspatel**



## Self-Retaining Retractors



**06-240**  
WEITLANER  
sharp  
130 mm

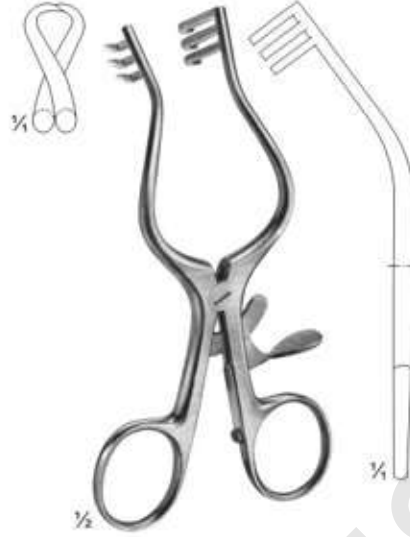

**06-241**  
WULLSTEIN  
sharp  
130 mm

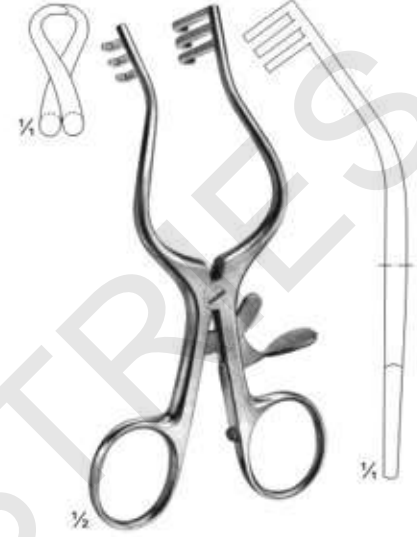

**06-242**  
WULLSTEIN  
blunt  
130 mm



**06-243**  
WEITLANER  
sharp  
165 mm



**06-244**  
PLESTER  
blunt  
110 mm



**06-245**  
PERKINS  
130 mm

**Special Retractors**



**06-246**  
**JOLL ( FRIEDMAN )**  
 Thyroid- and vaginal retractor  
 155 mm



**06-247**  
**JACKSON BURROWS**  
 Retractor, blunt  
 185 mm



**06-248**  
**GELPI**  
 Vaginal retractor  
 135 mm



**06-249**  
**GELPI**  
 Skin- and vaginal retractor  
 175 mm



**06-250**  
**DE BAKEY**  
 Femur retractor  
 145 mm

## Lamina Spreaders



**06-251**  
CLOWARD  
155 mm



**06-252**  
CLOWARD  
135 mm



**06-253**  
INGE  
170 mm

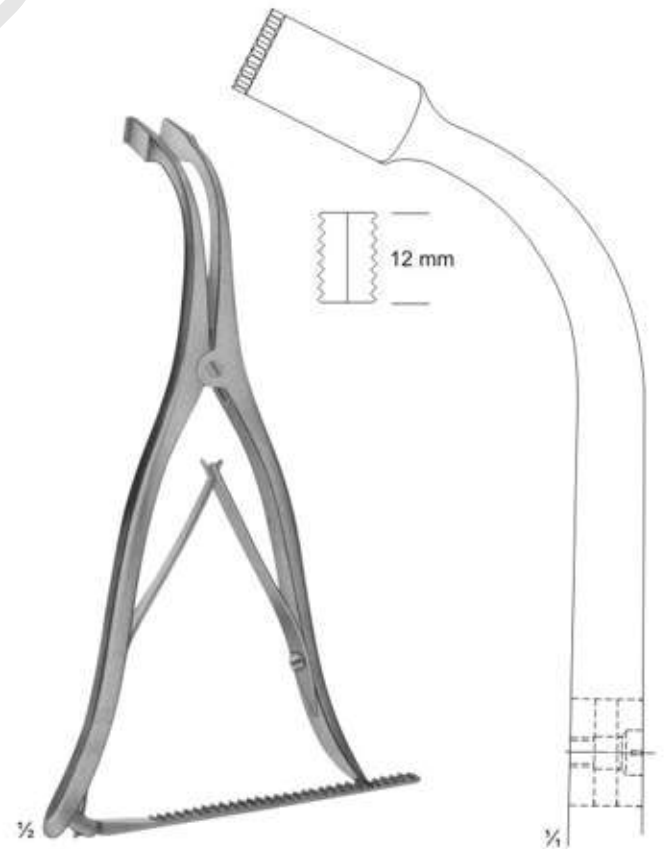

**06-254**  
INGE  
275 mm

## Abdominal Retractors



**06-255**  
GOSSET  
Blades:38 mm deep

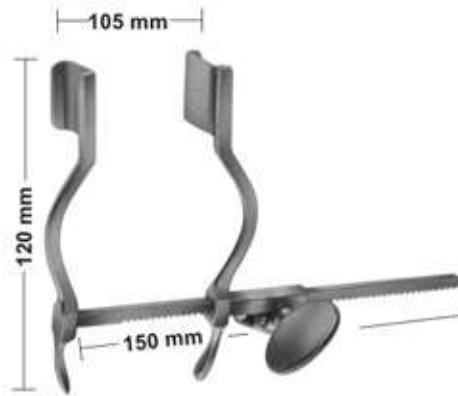

**06-256**  
HERTZLER  
Blades 20 X 25 mm

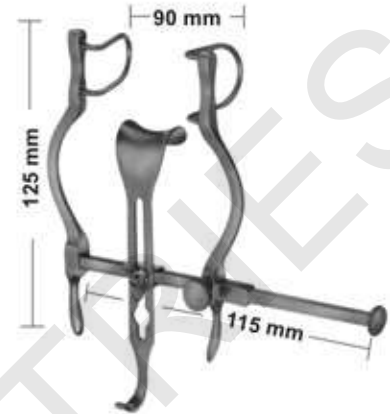

**06-257**  
BALFOUR-BABY  
Lateral blades 27 mm deep  
Center blade 21x24 mm

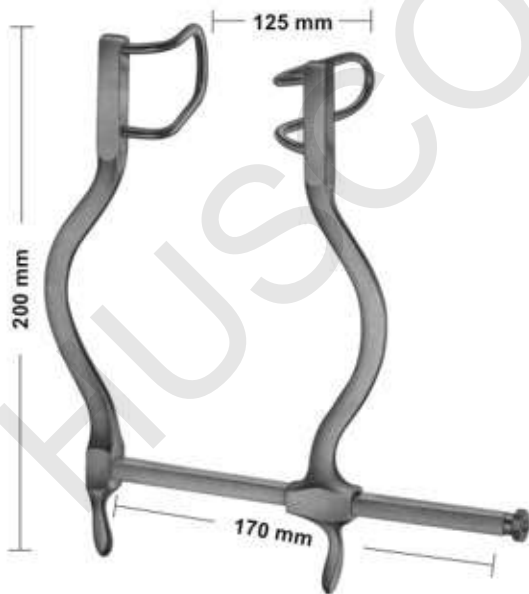

**06-258**  
GOSSET  
Blades:55mm deep

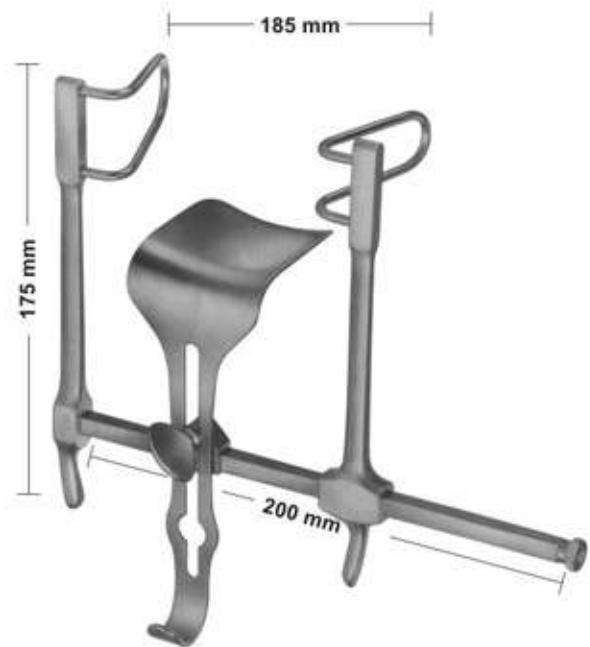

**06-259**  
GOSSET  
Lateral blades 58 mm deep  
Center blade 59 x 57 mm

# Abdominal Retractors

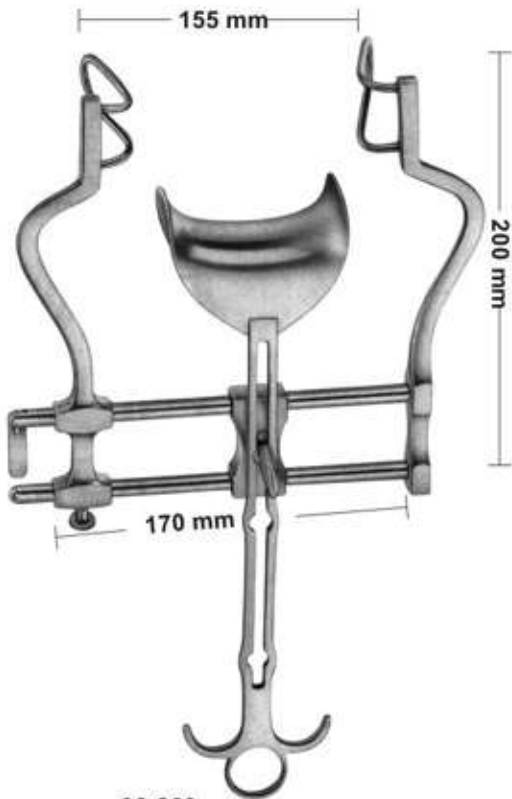

**06-260**  
BALFOUR  
Lateral blades 60 mm deep  
Center blade 47 x 80 mm



**06-261**  
BALFOUR  
Lateral blades 105 mm deep  
Center blade 107x 59 mm



**06-262**  
Center blade only  
54x80 mm

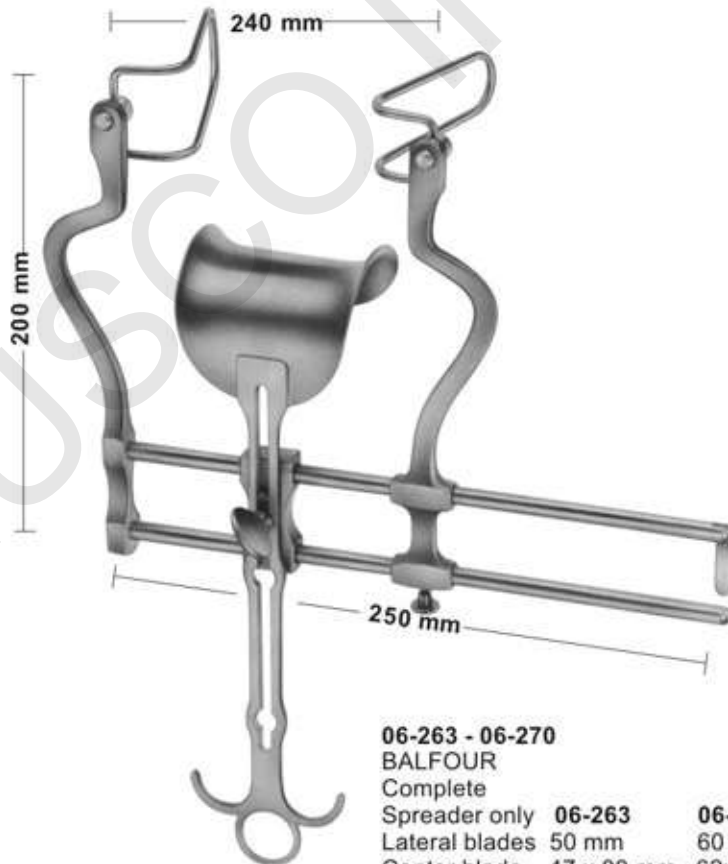

**06-263 - 06-270**  
BALFOUR  
Complete

|                |               |               |               |               |
|----------------|---------------|---------------|---------------|---------------|
| Spreader only  | <b>06-263</b> | <b>06-264</b> | <b>06-265</b> | <b>06-266</b> |
| Lateral blades | 50 mm         | 60 mm         | 75 mm         | 90 mm         |
| Center blade   | 47 x 80 mm    | 62x76 mm      | 80x80 mm      | 80x80 mm      |



Lateral blades  
**06-267** 50 mm deep  
**06-268** 60 mm deep  
**06-269** 75 mm deep  
**06-270** 90 mm deep  
 Sales Unit of blades: PR = pair



# Organ-, Tissue and Intestinal Grasping Forceps

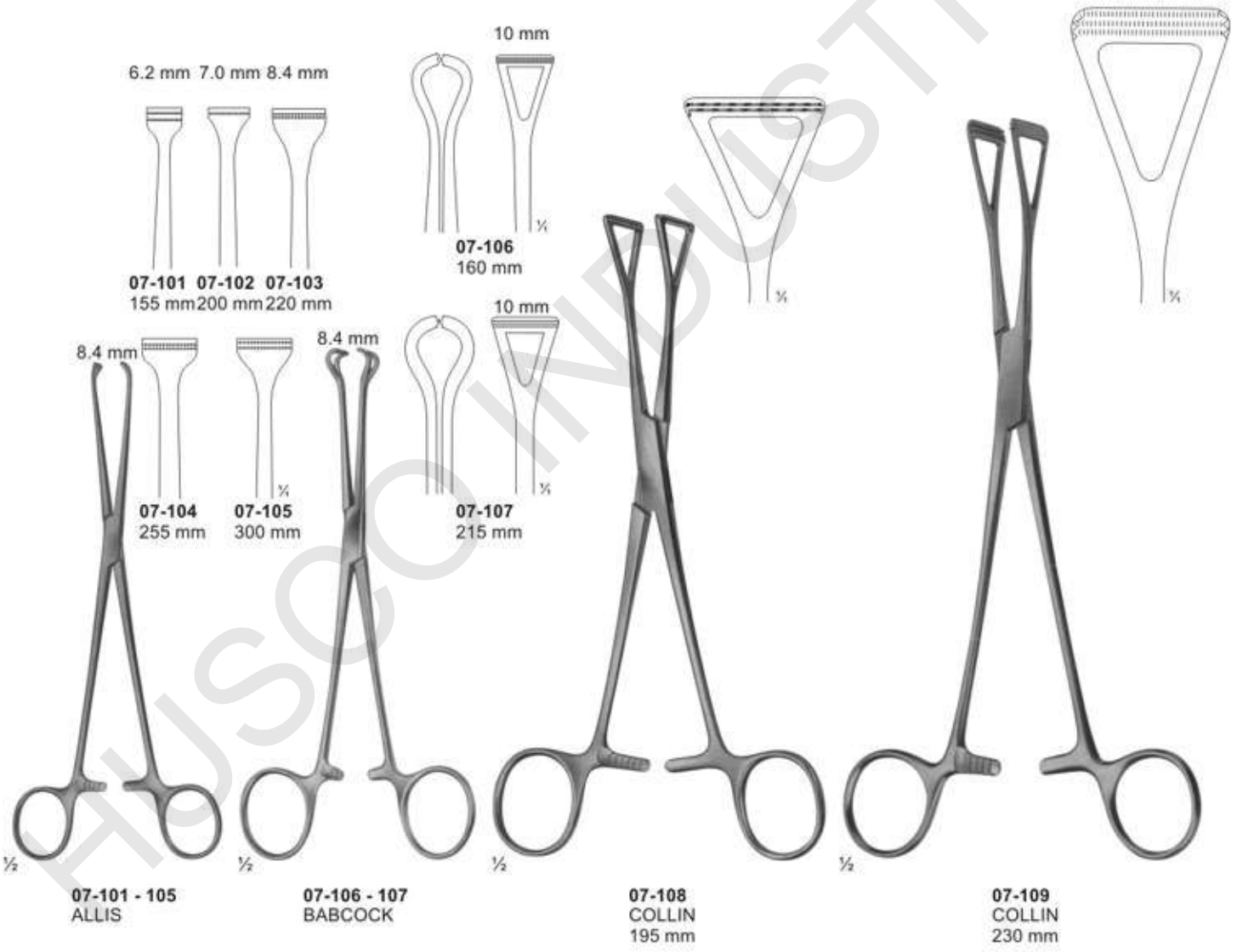

**Intestinal Clamps, soft elastic**

**ATRAUMATA**

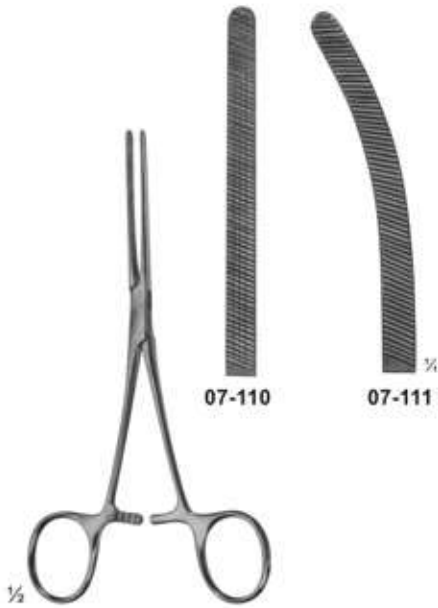

**07-110 - 111**  
**DOYEN**  
elastic  
165 mm

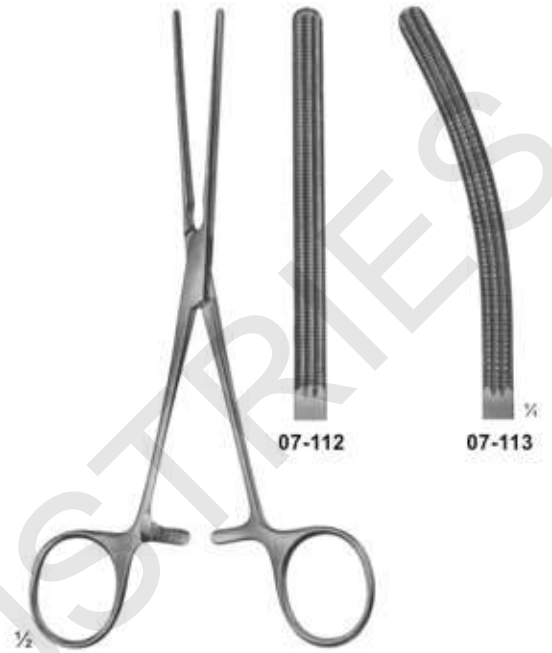

**07-112 - 113**  
**DOYEN**  
with elastic blades  
170 mm

**ATRAUMATA**

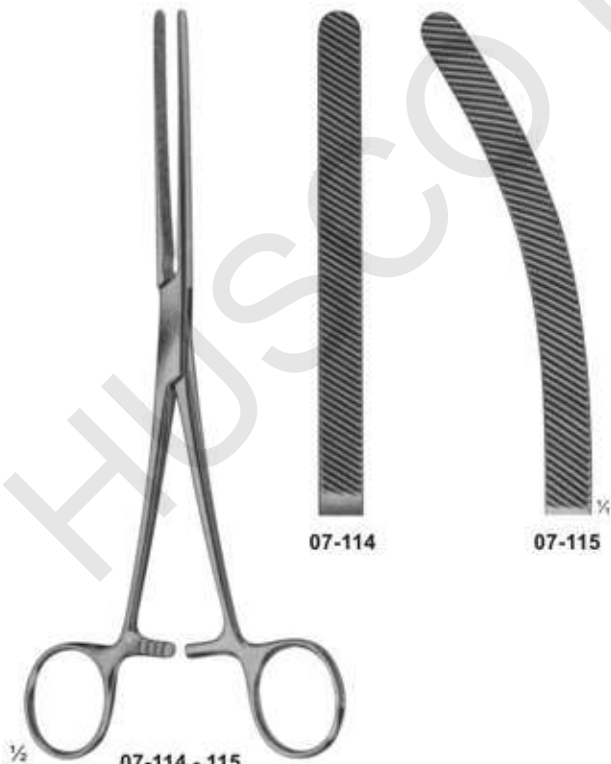

**07-114 - 115**  
**HARTMANN**  
with elastic blades  
200 mm



**07-116 - 117**  
**HARTMANN**  
with elastic blades  
200 mm

## Intestinal and Pylorus Clamps



**07-118**  
PAYR  
Intestinal clamp  
light pattern,  
for children  
180 mm

**07-119**  
PAYR  
200 mm

**07-120**  
PAYR  
275 mm

**07-121**  
PAYR  
Pylorus clamp  
315 mm

**ATRAUMATA**  
**Sigmoid Anastomosis Forceps**

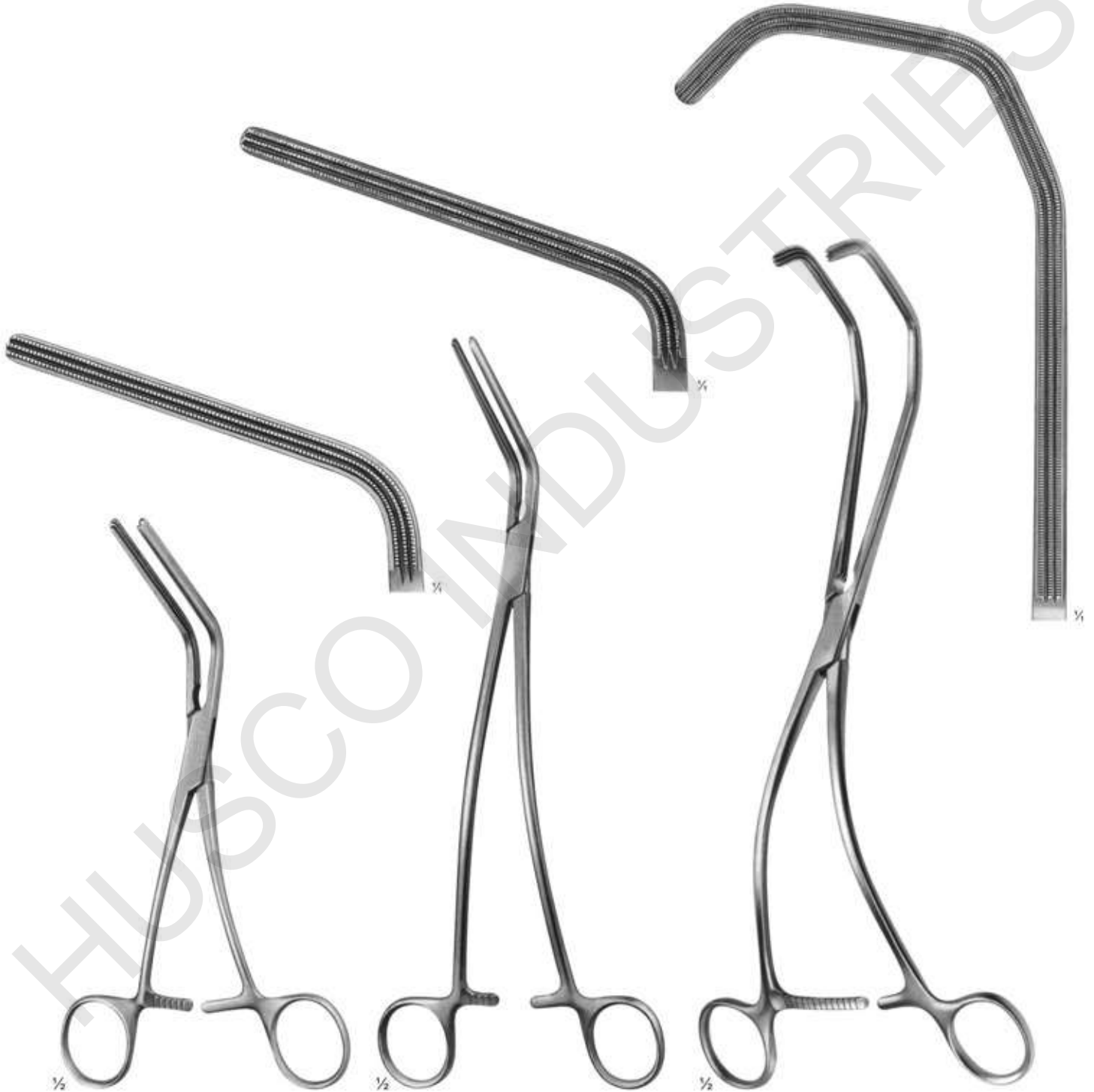

07-122  
MORRIS  
175 mm

07-123  
DE BAKY  
(MORRIS modif.)  
240 mm

07-124  
KERSTING  
270 mm

## Nasal Specula



**08-101**  
Martin  
13 cm / 5 1/8"



**08-102**  
SIMS  
160 mm

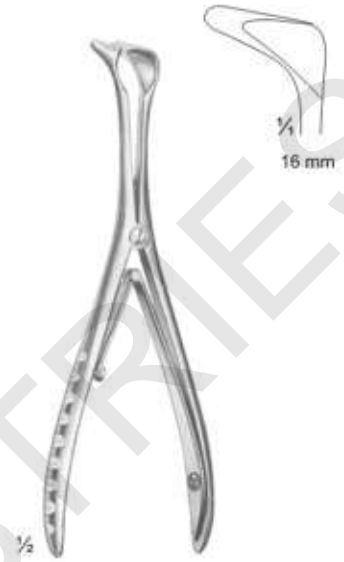

**08-103**  
Tieck-Halle  
13 cm / 5 1/8"



**08-104**  
Killian

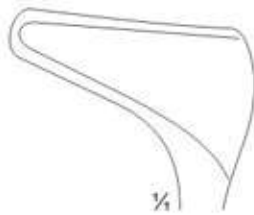

**Fig. 1**  
14 cm 5 4/8"  
35 mm

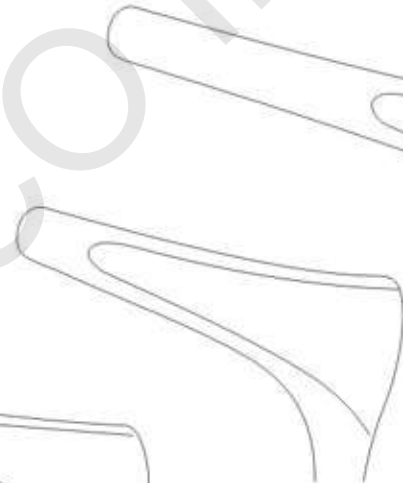

**Fig. 2**  
14,5 cm / 5 4/8"  
50 mm

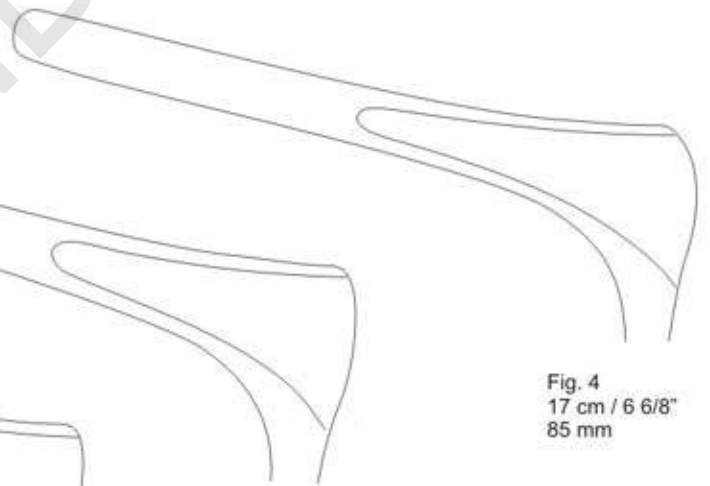

**Fig. 3**  
16 cm / 6 2/8"  
75 mm

**Fig. 4**  
17 cm / 6 6/8"  
85 mm

# Nasal Specula



**08-105**  
Cottle

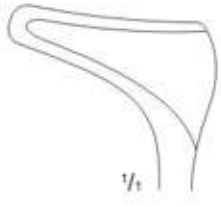

Fig. 1  
13,5 cm / 5 3/8"  
35 mm



Fig. 2  
14 cm / 5 4/8"  
50 mm

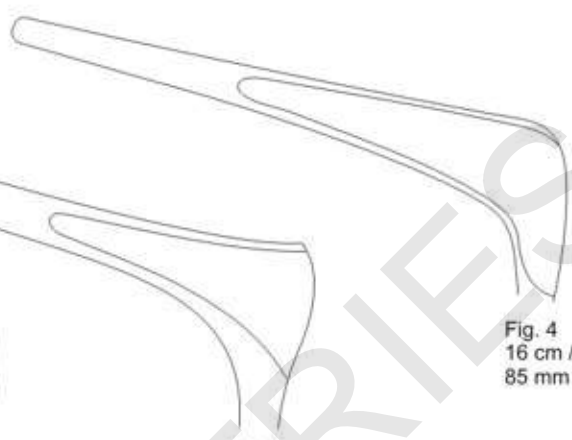

Fig. 3  
16 cm / 6 2/8"  
75 mm

Fig. 4  
16 cm / 6 2/8"  
85 mm



**08-106**  
Goldsmith (Thudichum)  
6,5 cm / 2 4/8"



Fig. 1  
21,0 x 9,5 mm

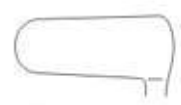

Fig. 2  
21,0 x 10,5 mm

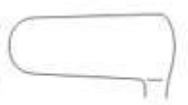

Fig. 3  
21,0 x 11,5 mm



**08-107**  
Mod. Wien 2  
13,5 cm / 5 7/8"

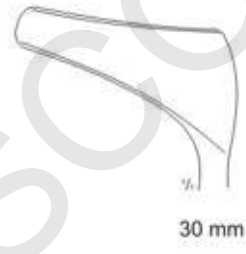

Fig. 1  
30 mm



**08-108**  
Hartmann-Halle  
16 cm / 6 7/8"



Fig. 1  
27 mm

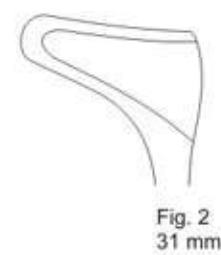

Fig. 2  
31 mm



Fig. 3  
35 mm

## Anuscopy-Sphincteroscopes



**08-109**  
IVES-FANSLER  
Anuscopy  
145 mm  
Ø24mm



**08-110**  
KELLY  
Sphincteroscope  
160 mm  
Ø21mm



**08-111**  
KELLY  
Sphincteroscope  
160 mm  
Ø27mm

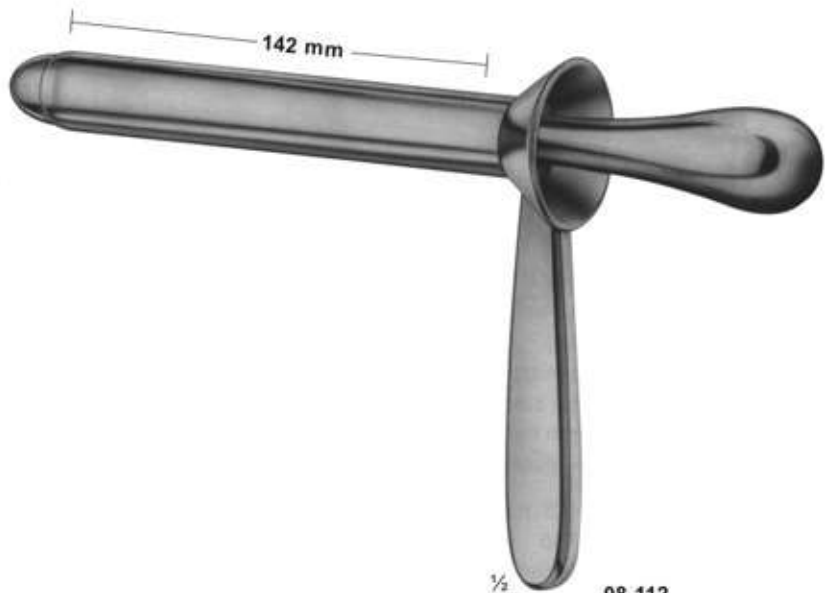

**08-112**  
KELLY  
Proctoscope  
140 mm  
Ø22mm

# Haemorrhoidal Forceps

## ATRAUMATA

### Pressure Clamp

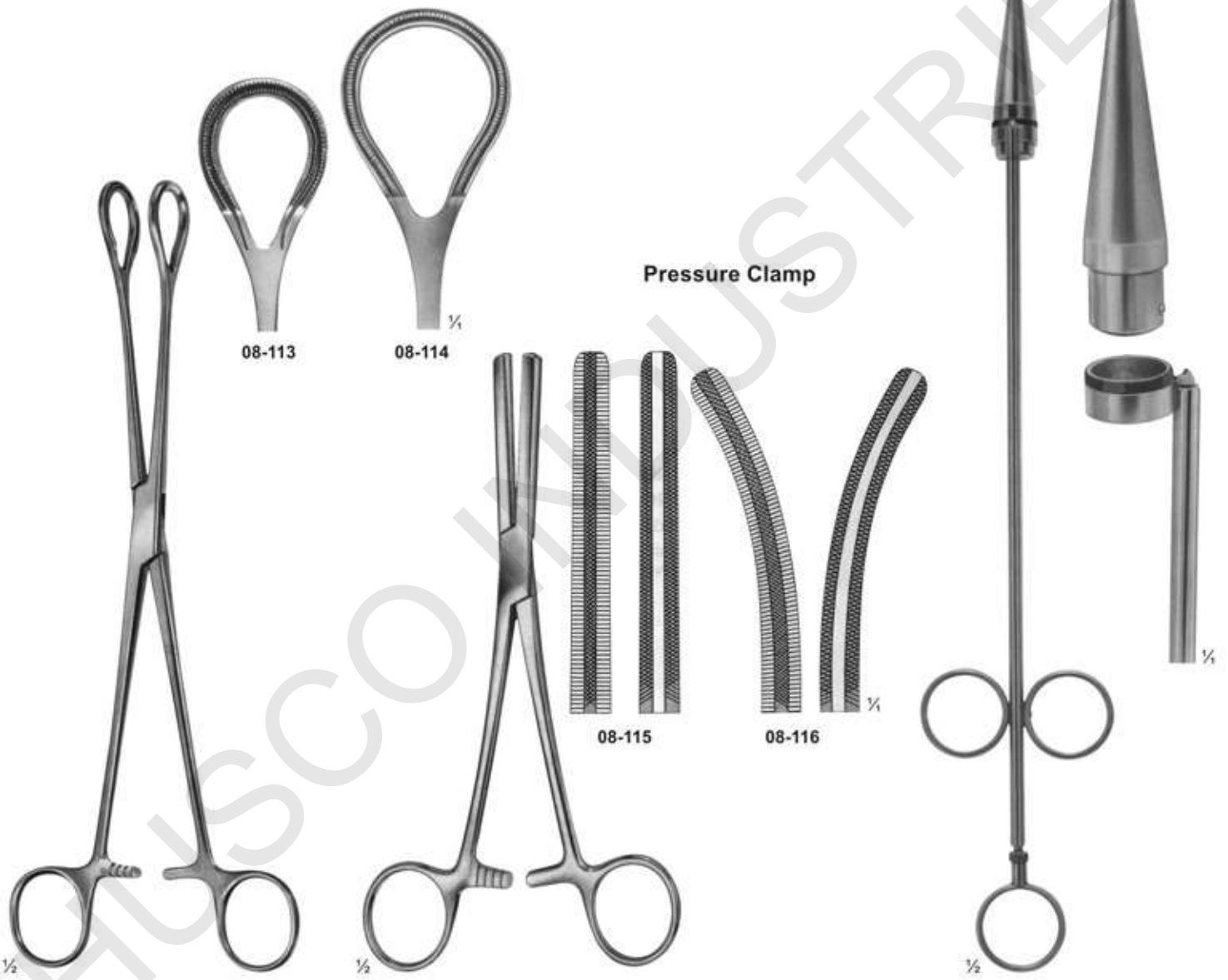

**08-113 - 08-114**  
250 mm  
08-114  
270 mm

**08-115 - 08-116**  
FERGUSON  
200 mm

**08-117**  
RUDD  
Haemorrhoidal ligator  
with loading  
attachment and 100  
ligature rubber rings  
315 mm



## Gall Duct Forceps



**08-118**  
LOWER  
180 mm



**08-119**  
LAHEY ( SWEET )  
190 mm



**08-120**  
LAHEY  
220 mm

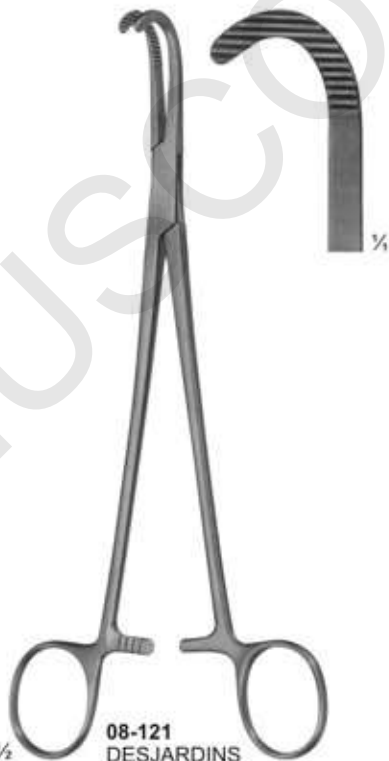

**08-121**  
DESJARDINS  
Gall duct-and cystic forceps  
210 mm



**08-122**  
NISSEN  
Gall duct-and cystic forceps  
215 mm

# Gall Duct Dilators and Gall Stone Scoops

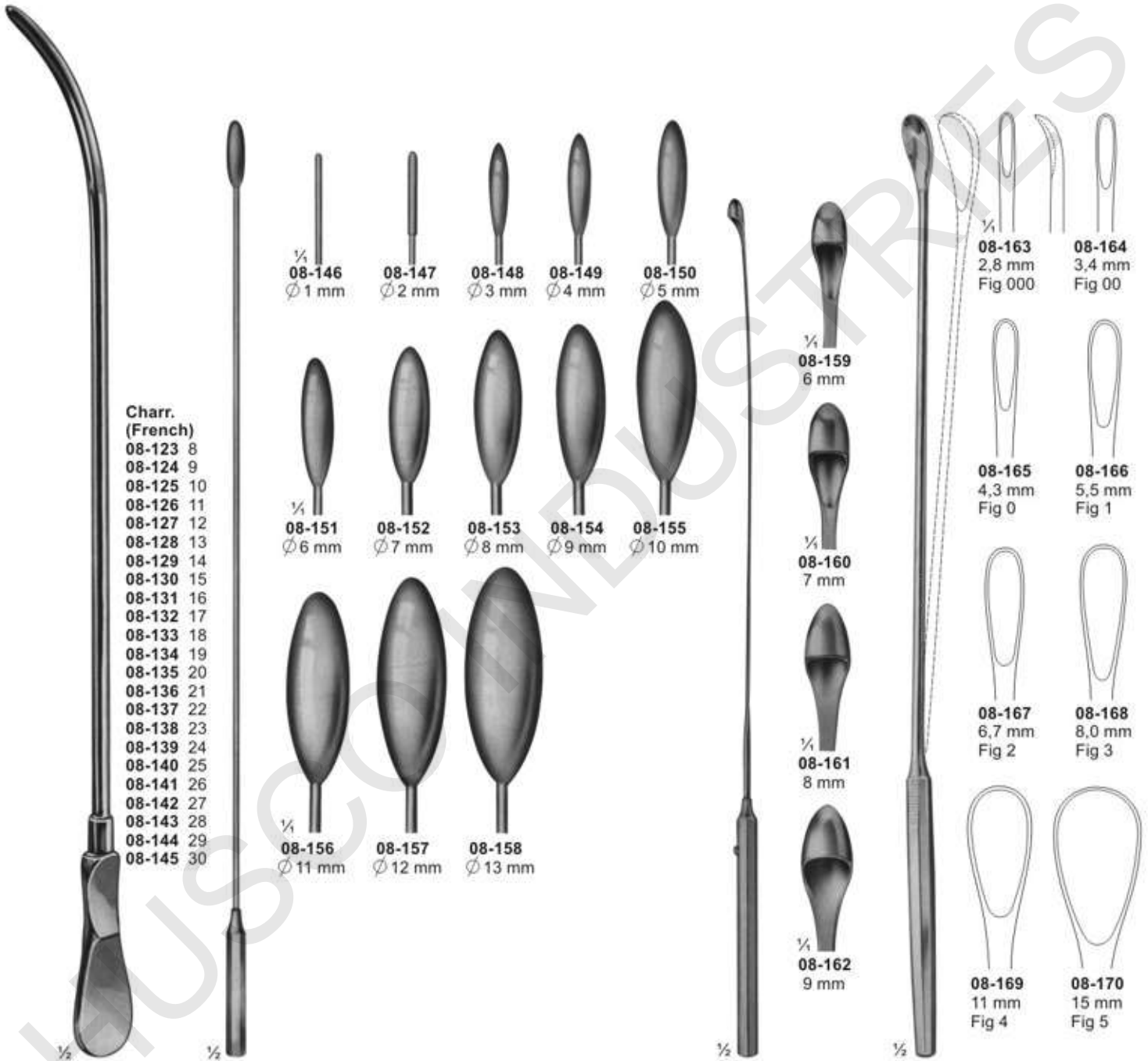

**08-123 - 08-145**  
DITTEL  
Metall bougies and dilating sounds, stiff  
345 mm

**08-146 - 08-158**  
BAKES  
Common bile duct dilators, malleable  
08-146 - 08-150 315 mm  
08-151 - 08-158 320 mm

**08-159 - 08-162**  
DESJARDINS  
Probe and catch with flexible shaft  
300 mm

**08-163 - 08-170**  
LUER-KOERTE modif with malleable shaft  
310 mm

## Gall Stone Forceps

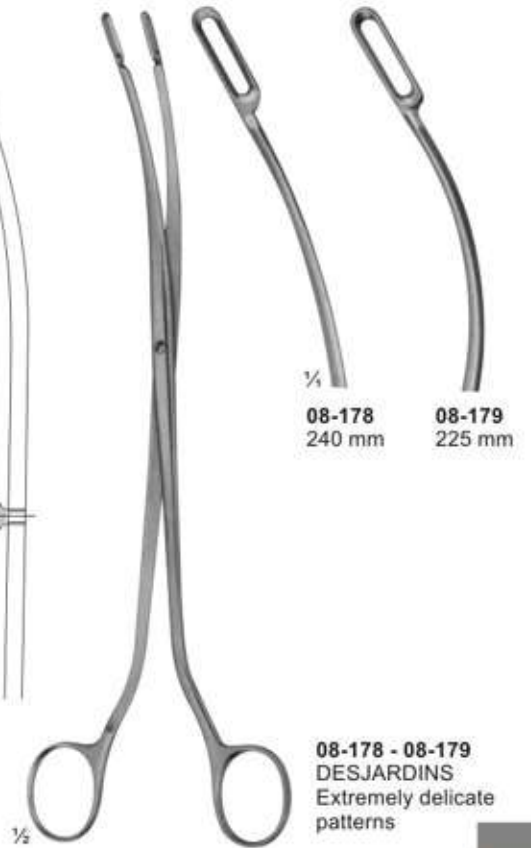
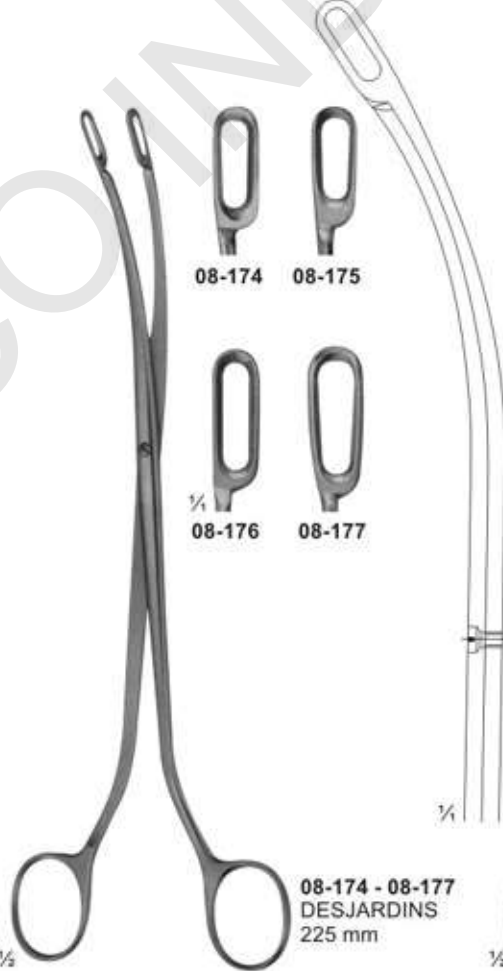
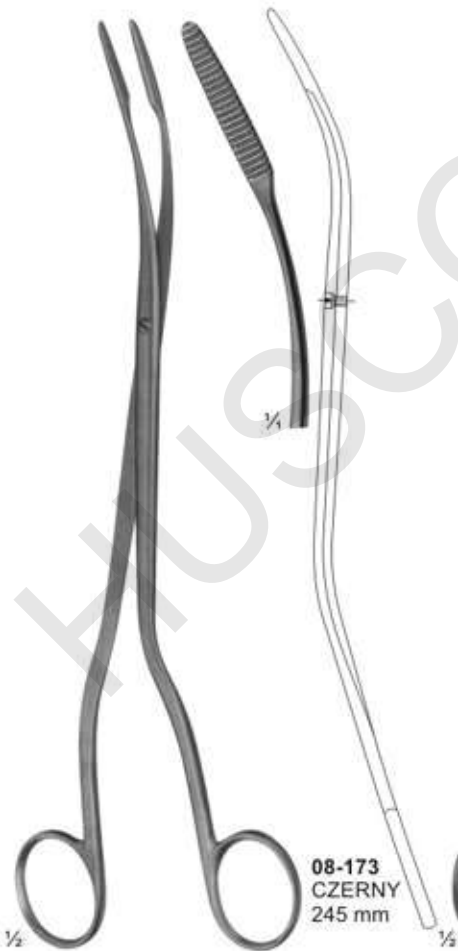
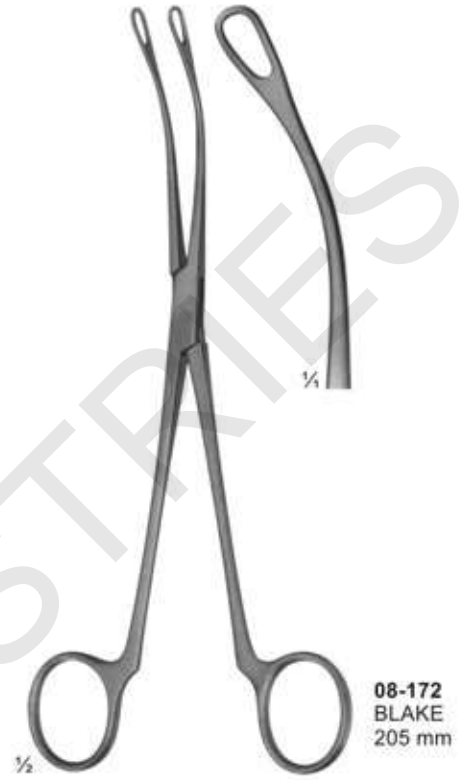

# Kidney Clamps

## ATRAUMATA



¼  
08-180  
240 mm

08-181  
230 mm

¼

¼

08-183 08-184

08-185

½  
08-180 - 08-181  
GUYON

½  
08-182  
GUYON  
230 mm

½  
PEAN  
08-183 - 195 mm  
08-184 - 220 mm  
08-185 - 230 mm

## Kidney Stone Forceps



08-186 - 08-189  
RANDALL  
225 mm



08-190 - 08-192  
RANDALL  
190 mm

## Bladder Retractors



**09-101**  
JUDD-MASSON  
Bladder-and suprapubic  
retractor



**09-102**  
MILLIN  
Center bladder for  
retro pubic prostatectomy



**09-103**  
MILLIN  
Bladder retractor, complete  
105X45 mm



**09-104**  
LEGUEU  
Bladder retractor  
Center blade  
80 x 31 mm



**09-105**  
KOCHER  
Bladder spatula  
235 mm

# Trocars

**09-106**  
KLIMA ROSEGGER  
35 X 1,8 mm  
Sternal puncture needle

**09-107**  
Universal trocar  
with 4 tips

**09-108 - 112**  
Inside diam. Outside diam  
09-108 2,2 mm 3,0 mm  
09-109 3,0 mm 4,0 mm  
09-110 4,0 mm 5,0 mm  
09-111 5,0 mm 6,0 mm  
09-112 5,5 mm 6,5 mm  
for hydrocele and abdominal puncture

**09-113 - 116**  
Inside diam. Outside diam  
09-113 2,2 mm 3,0 mm  
09-114 3,0 mm 4,0 mm  
09-115 4,0 mm 5,0 mm  
09-116 5,0 mm 6,0 mm  
for abdominal puncture,  
with stop-cock and lateral  
drain

**09-117 - 118**  
Inside diam. Outside diam  
09-117 6,5 mm 8,0 mm  
09-118 9,0 mm 10,0 mm  
Empyema trocar  
BUELEU

**09-119 - 122**  
Inside diam. Outside diam  
09-119 3,0 mm 4,0 mm  
09-120 3,6 mm 4,6 mm  
09-121 4,3 mm 5,3 mm  
09-122 5,0 mm 6,0 mm  
Gall bladder trocars. OCHSNER

**09-123**  
PIERCE  
Antrum trocar  
Ø 4,0 mm

**09-124**  
COAKLEY  
Antrum trocar  
3,0 mm

Dimensions: 100 mm, 110 mm, 80 mm, 80 mm, 100 mm, 100 mm

Labels: Luer Lock, NELSON, Record Cone, Luer - Lock Cone

## Vaginal Specula



**10-101**  
COLLIN  
for children  
53 x 10 mm

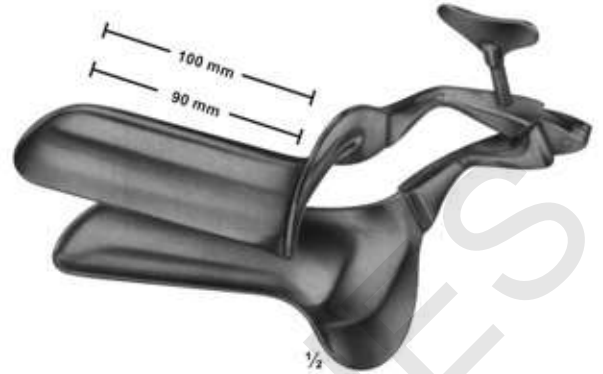

**10-102 - 105**  
COLLIN  
10-102 100/90mm 28 mm  
10-103 100/90mm 32 mm  
10-104 105/95mm 35 mm  
10-105 115/105mm 40 mm  
Total length/working length width



**10-106**  
COLLIN  
for virgins  
95/85 x 18 mm



**10-107**  
CUSCO  
for virgins  
75 x 17 mm



**10-108**  
CUSCO  
for virgins  
75 x 17 mm

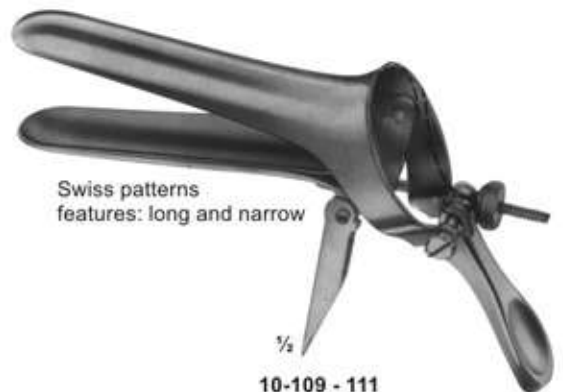

**10-109 - 111**  
CUSCO  
10-109 92X23-25 mm  
10-110 100x25-27 mm  
10-111 110x27-30 mm



## Vaginal Specula- Sets, upper and lower blades



**10-112 - 114**  
GRAVE  
10-112 75X20 mm  
10-113 95X30 mm  
10-114 105X33 mm

½



**10-115 - 116**  
PEDERSON  
10-115 100X22 mm  
10-116 120X25 mm

½



**10-117 - 118**  
BRIESKY  
10-117 72X25 mm / 77X30 mm 140 mm  
10-118 75X30 mm / 92X38 mm 170 mm

½



½

**10-119**  
SIMS  
70 X 26 mm / 75 X 30 mm  
75 X 30 mm / 80 X 35 mm  
80 X 36 mm / 90 X 40 mm  
175 mm



½

**10-120 - 122**  
SEIDL  
10-120 80X8 mm  
10-121 80X10 mm  
10-122 90X14 mm  
For children and infants  
170 mm



½

**10-123**  
KRISTELLER  
70X15 mm, ( 170 mm )  
For children



½

**10-124 - 10-126**  
KRISTELLER  
10-124 70X27 mm  
10-125 75X30 mm  
10-126 90X36 mm  
175 mm

## Vaginal Specula- upper and lower blades



10-127 - 131  
KRISTELLER  
10-127 110X18 mm  
10-128 110X20 mm  
10-129 110X27 mm  
10-130 110X30 mm  
10-131 110X36 mm  
220 mm

10-132 - 10-135  
KRISTELLER  
Upper blades

10-136 - 10-139  
KRISTELLER  
Lower blades

# Vaginal Specula



width of blades  
35 mm    45 mm    60 mm

length of blades  
60 mm  
90 mm  
120 mm  
160 mm

width of blades  
35 mm    45 mm    60 mm  
**10-143**    **10-146**    **10-150**  
**10-144**    **10-147**    **10-151**  
**10-145**    **10-148**    **10-152**  
                 **10-149**    **10-153**

$\frac{1}{2}$   
**10-143 - 10-153**  
**DOYEN**  
240 mm

## Vaginal Retractors



1/2  
**10-154**  
JOLL (FRIEDMAN)  
155 mm



1/2  
**10-155**  
RICHTER  
170 mm



1/2  
**10-156**  
GELPI  
135 mm



1/2  
**10-157**  
GELPI  
175 mm

## Uterine Dilators



11-101 - 143  
HEGAR  
with very conical point  
185 mm

|        |    |    |        |    |     |
|--------|----|----|--------|----|-----|
| 11-101 | 1  | mm | 11-123 | 23 | mm  |
| 11-102 | 2  | mm | 11-124 | 24 | mm  |
| 11-103 | 3  | mm | 11-125 | 25 | mm  |
| 11-104 | 4  | mm | 11-126 | 26 | mm  |
| 11-105 | 5  | mm | 11-127 | 1  | ½mm |
| 11-106 | 6  | mm | 11-128 | 2  | ½mm |
| 11-107 | 7  | mm | 11-129 | 3  | ½mm |
| 11-108 | 8  | mm | 11-130 | 4  | ½mm |
| 11-109 | 9  | mm | 11-131 | 5  | ½mm |
| 11-110 | 10 | mm | 11-132 | 6  | ½mm |
| 11-111 | 11 | mm | 11-133 | 7  | ½mm |
| 11-112 | 12 | mm | 11-134 | 8  | ½mm |
| 11-113 | 13 | mm | 11-135 | 9  | ½mm |
| 11-114 | 14 | mm | 11-136 | 10 | ½mm |
| 11-115 | 15 | mm | 11-137 | 11 | ½mm |
| 11-116 | 16 | mm | 11-138 | 12 | ½mm |
| 11-117 | 17 | mm | 11-139 | 13 | ½mm |
| 11-118 | 18 | mm | 11-140 | 14 | ½mm |
| 11-119 | 19 | mm | 11-141 | 15 | ½mm |
| 11-120 | 20 | mm | 11-142 | 16 | ½mm |
| 11-121 | 21 | mm | 11-143 | 17 | ½mm |
| 11-122 | 22 | mm |        |    |     |



11-144 - 152  
HEGAR  
205 mm

|        |       |    |
|--------|-------|----|
| 11-144 | 1+2   | mm |
| 11-145 | 3+4   | mm |
| 11-146 | 5+6   | mm |
| 11-147 | 7+8   | mm |
| 11-148 | 9+10  | mm |
| 11-149 | 11+12 | mm |
| 11-150 | 13+14 | mm |
| 11-151 | 15+16 | mm |
| 11-152 | 17+18 | mm |

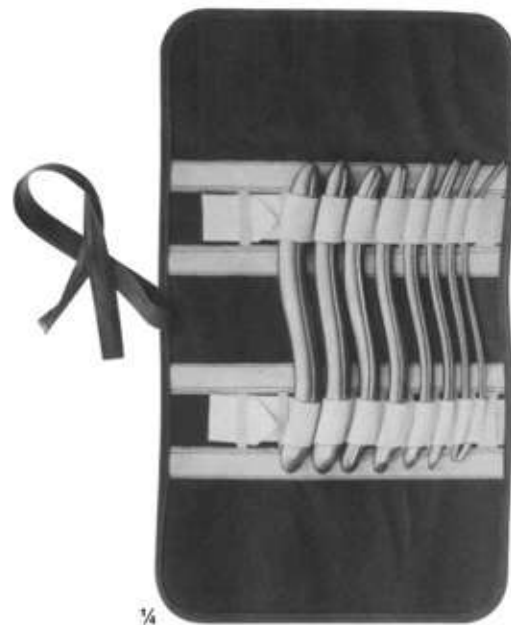

11-153  
HEGAR  
Uterine dilator set, in canvas  
roll with 8 dilators.

## Uterine Probes



## Uterine Dressing Forceps



Jaws with longitudinal groove

## Polypus-and Ovum Forceps



**11-164**  
HEYWOOD-SMITH  
200 mm

**11-165**  
KELLY  
320 mm

**11-166**  
HEYWOOD-SMITH  
250 mm

**11-167**  
NOTO  
280 mm



# Ear Curettes



**12-101**  
Langenbeck  
13 cm / 5 1/8"

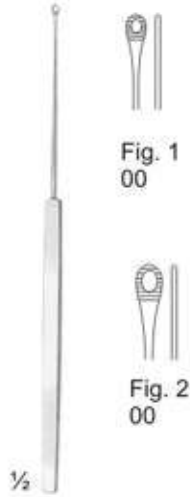

**12-102**  
Shapleigh  
15 cm / 5 1/8"

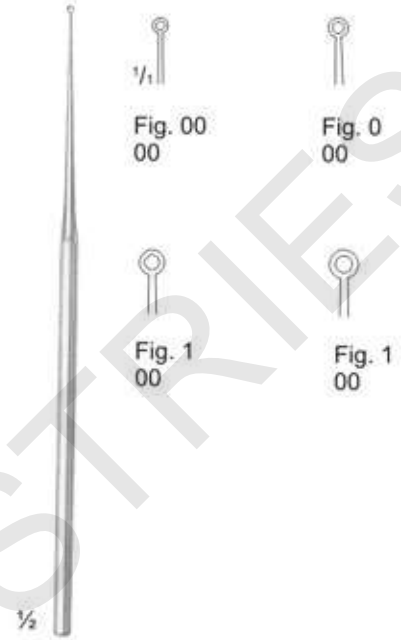

**12-103**  
Buck  
17cm / 6 6/8"



**12-104**  
Buck  
15 cm / 6 6/8"

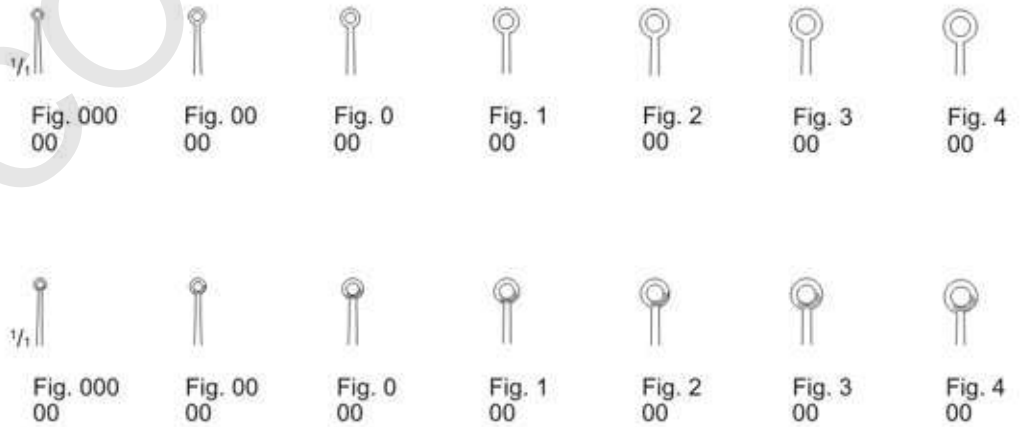

## Biopsy Curettes

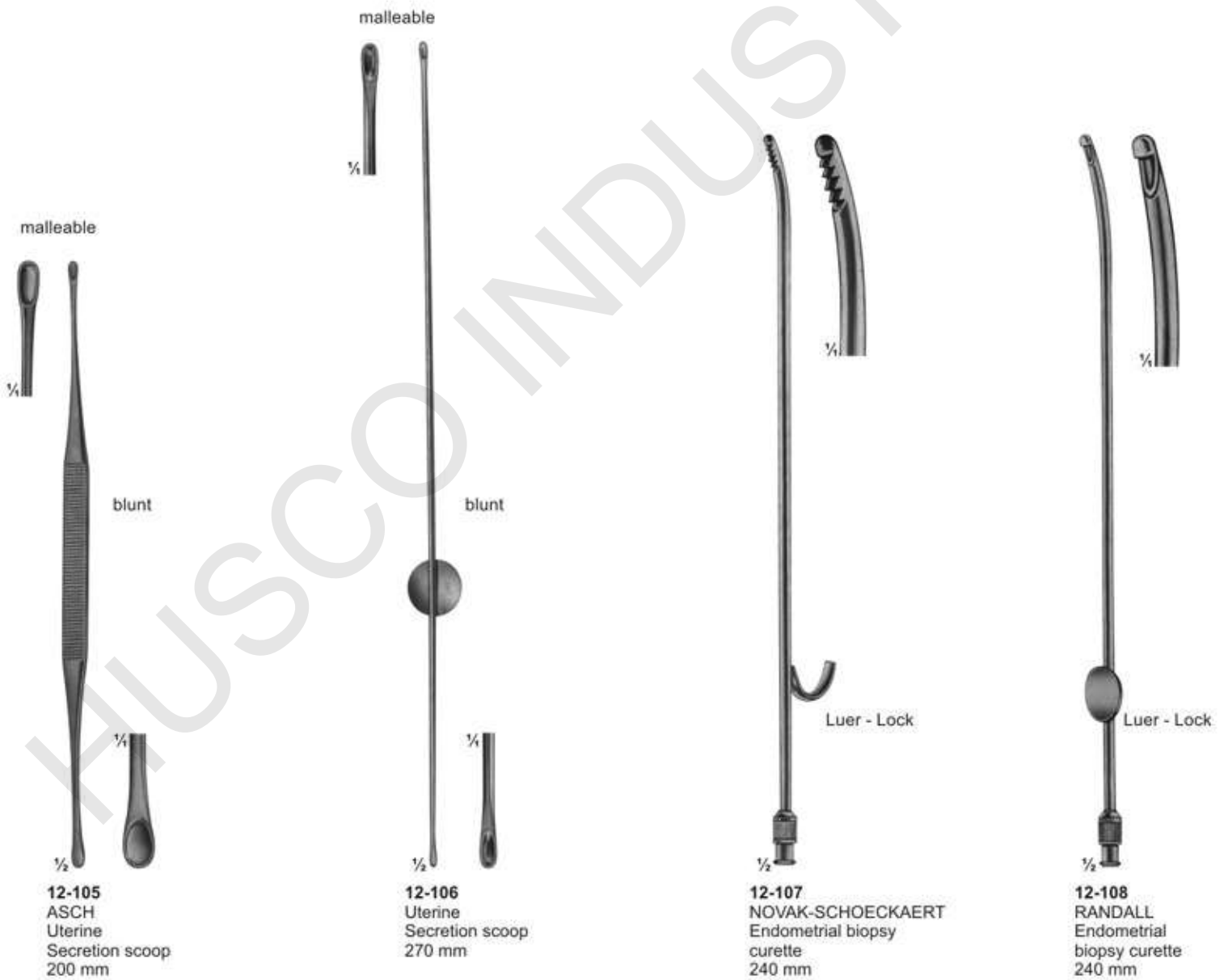

## Ear Polypus Forceps



**12-109**  
Hartmann-Wullstein  
shaft length  
85 mm



**12-110**  
Hartmann-Wullstein  
shaft length  
85 mm



**12-111**  
Hartmann  
shaft length  
85 mm



**12-112**  
Hartmann  
shaft length  
85 mm



$\frac{1}{2}$   
**12-109 - 12-119**

**12-113**  
14 cm / 5 4/8"  
shaft length  
140 mm

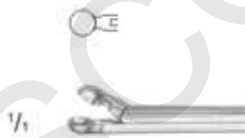

$\frac{1}{4}$   
**12-114**  
Hartmann-Herzfelr  
2,0 mm  
shaft length  
85mm



**12-115**  
Hartmann  
3 mm  
shaft length  
85mm



**12-116**  
shaft length  
85mm



**12-117**  
Hartmann-Hoffmar  
2,0 mm  
85mm

**12-118**  
2,5 mm  
85 mm

**12-119**  
3,0 mm  
85 mm

## Biopsy forceps for rectum

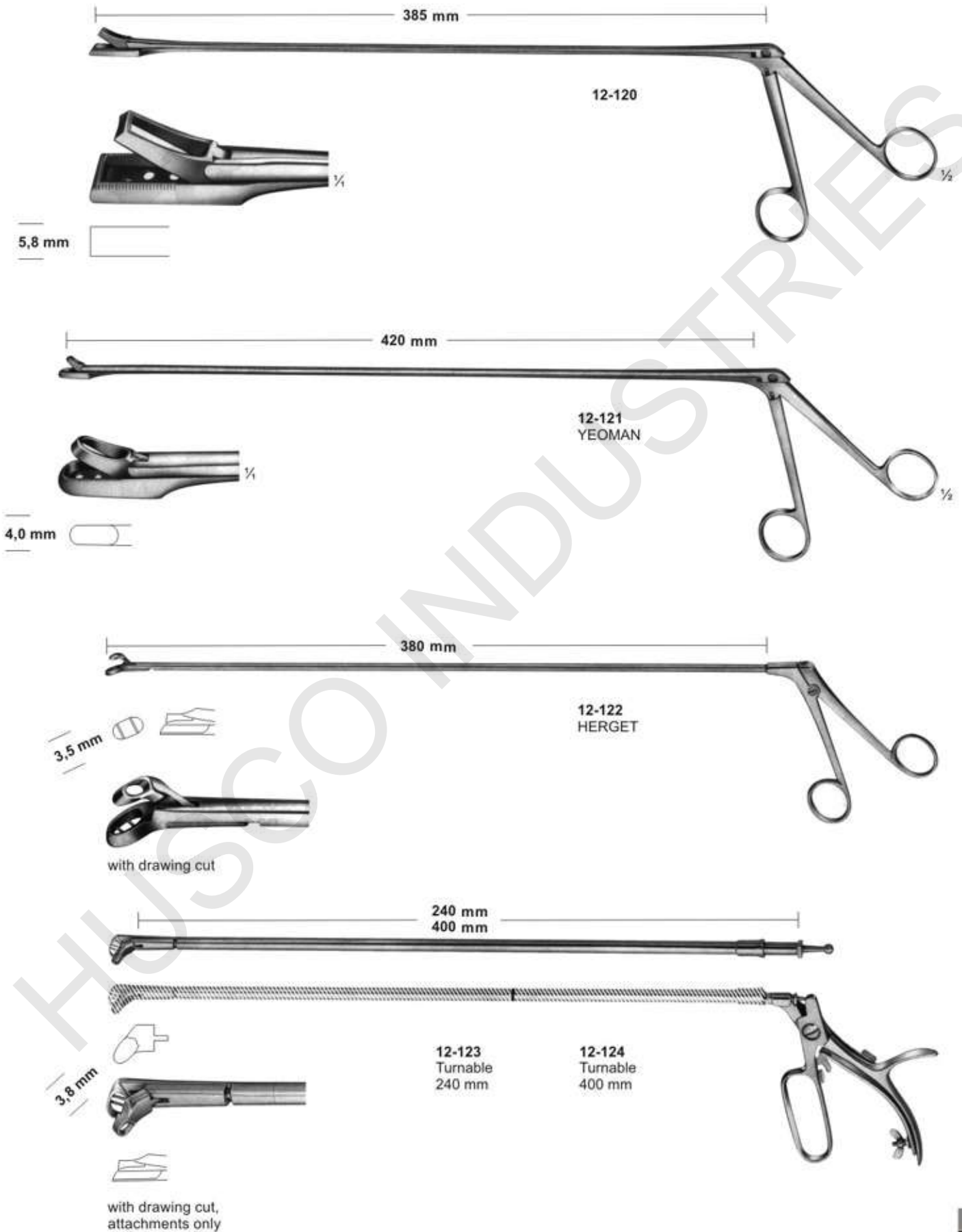

# Biopsy Forceps

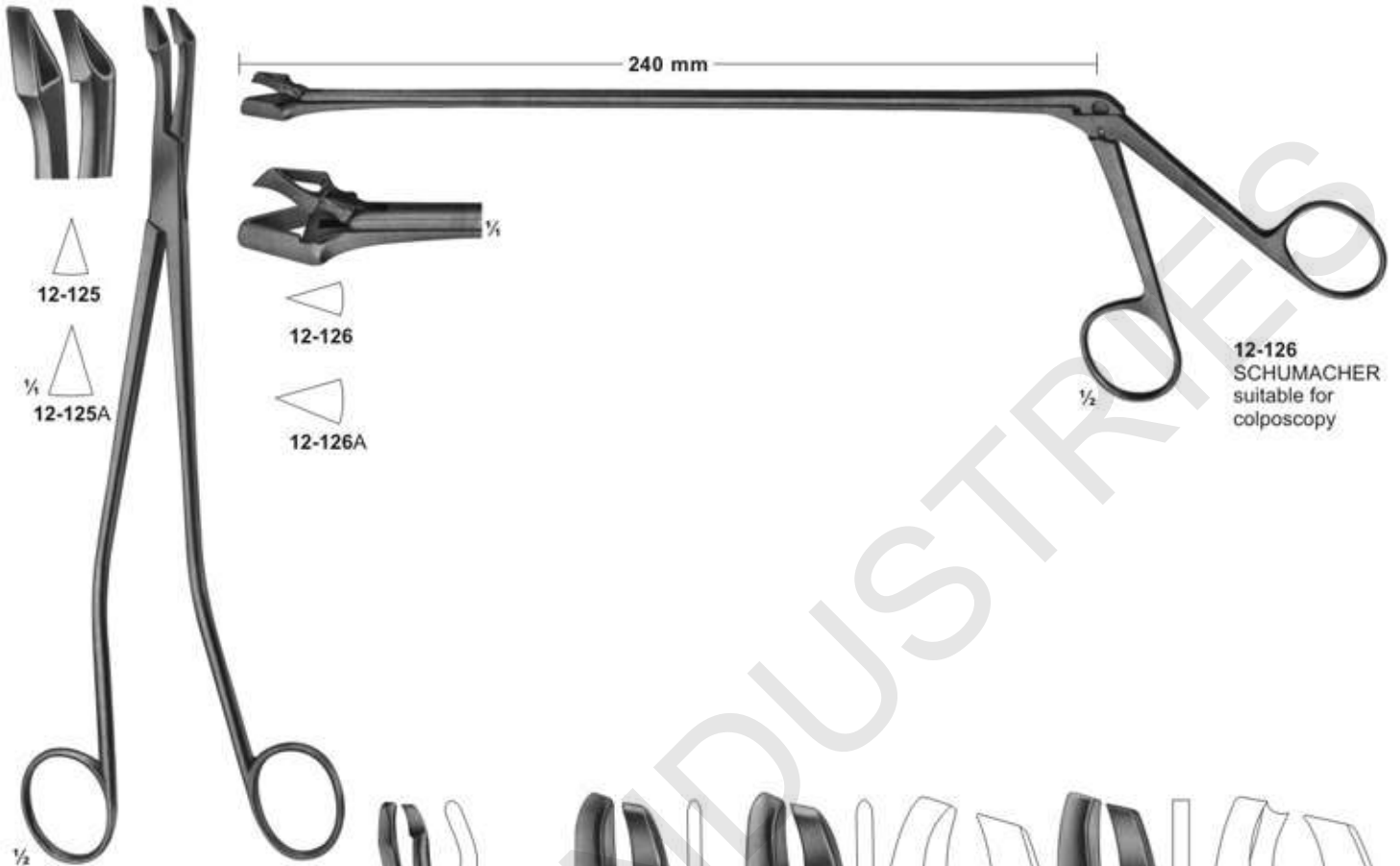

12-125

12-125A

12-126

12-126A

12-126 SCHUMACHER suitable for colposcopy

12-125 SCHUMACHER 240mm

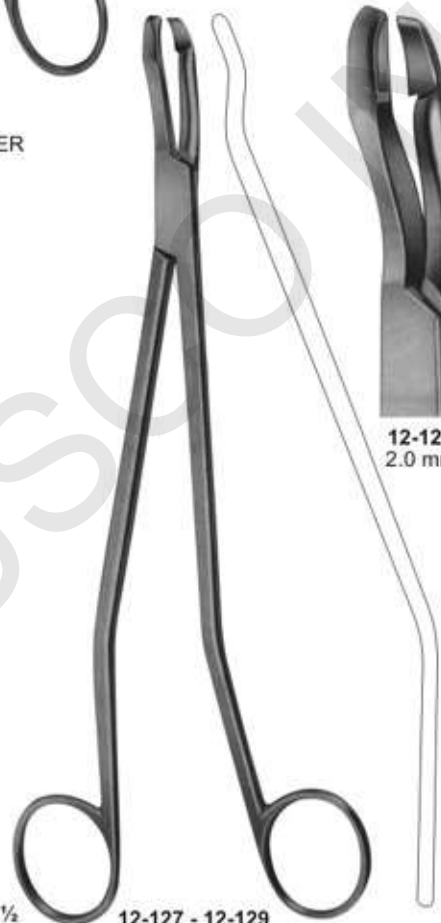

12-127 - 12-129 SEIDL DBP Biopsy forceps, bayonet shaped for portio, vagina and vulva 240mm



12-127 2.0 mm



12-128 2.4 mm



12-129 2.4 mm

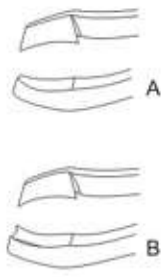

# Biopsy Forceps

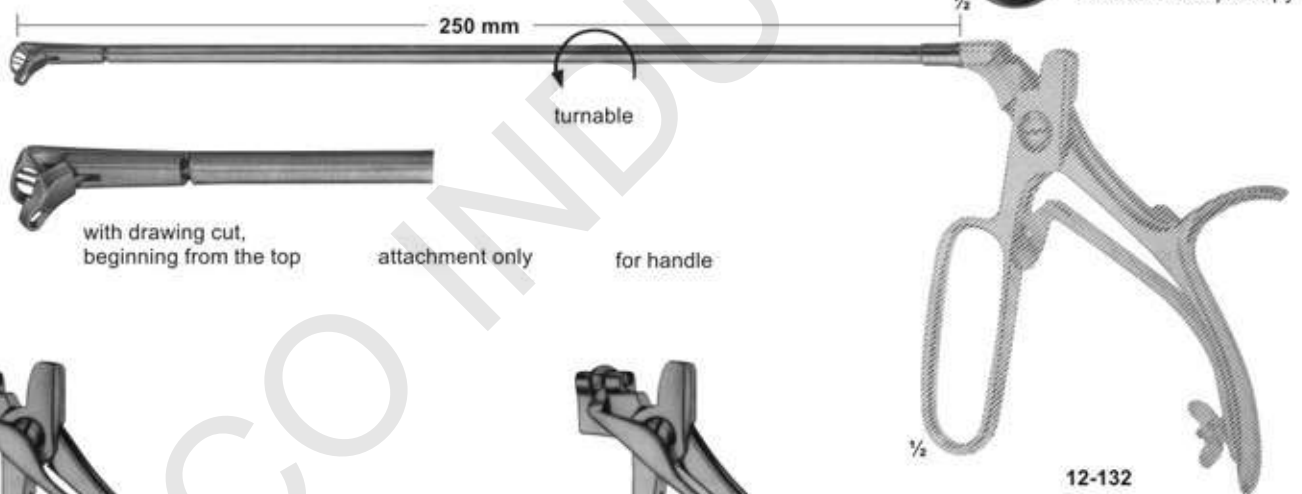
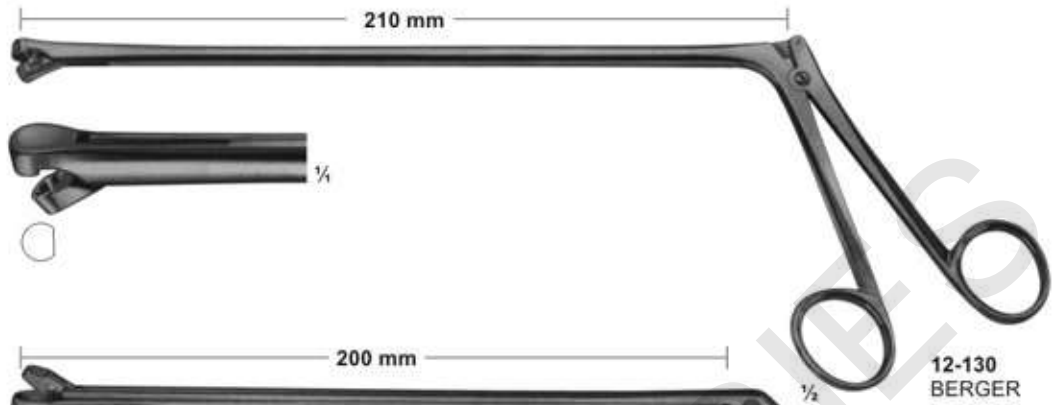

with drawing cut, beginning from the top      attachment only      for handle



12-135 BRUENINGS 200 mm Length  
12-136 BRUENINGS 250 mm Length



12-137 12-137A  
12-137 KRAUSE ( Biopsy tip )



12-138 SCHEINMANN ( Biopsy tip )



12-139 SCHUMACHER ( Biopsy tip )  
with drawing cut

# Uterine Scoops



12-140  
SIMON  
240 mm

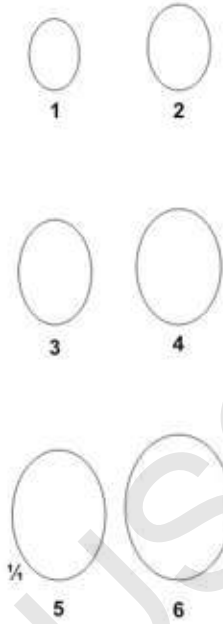

12-141  
SCHROEDER  
310 mm

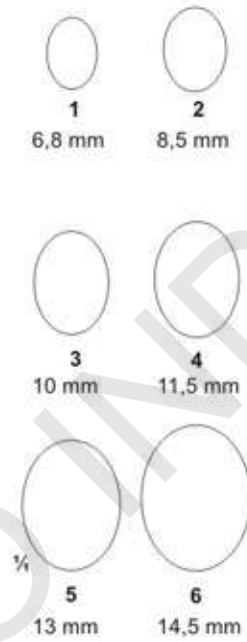

12-142  
RECAMIER  
300 mm

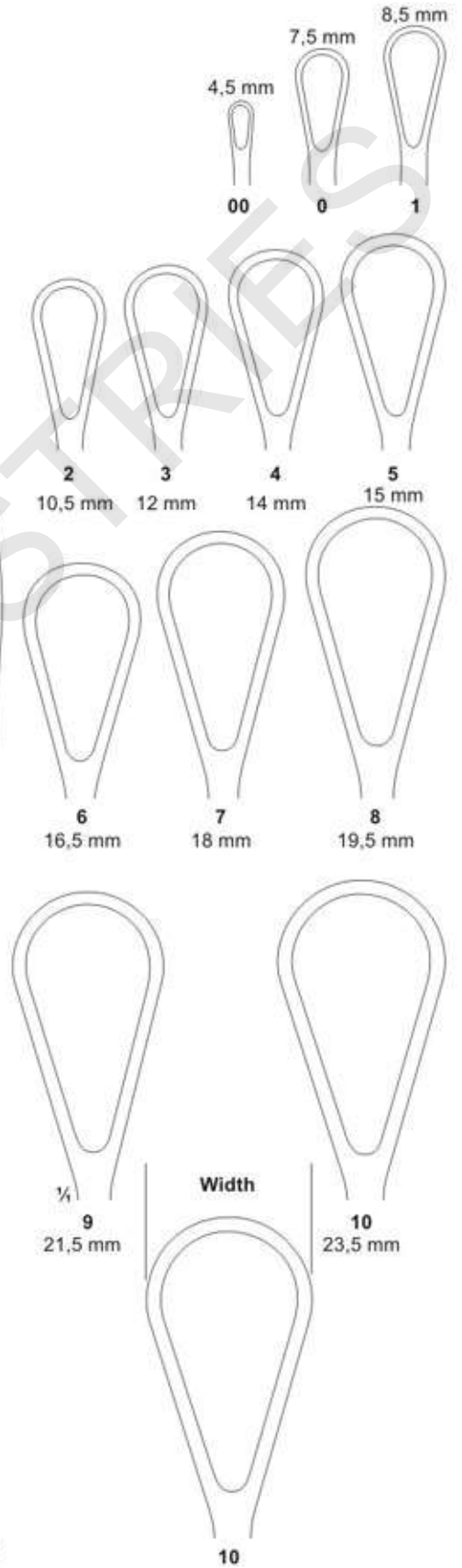

## Obstetrical Forceps



**13-101**  
NAEGELE  
355 mm



**13-102**  
NAEGELE  
400 mm



**13-103**  
SIMPSON-BRAUN  
305mm



# Obstetrics- Placenta and Ovum Forceps



Fig: 1  
13-104

Fig: 2  
13-105

Fig: 3  
13-106

Fig: 1  
13-107

Fig: 2  
13-108

Fig: 3  
13-109

13-104 - 106  
WINTER  
290 mm

13-107 - 109  
WINTER  
290 mm

13-110  
SAENGER  
275 mm

## Tound-and Tracheal Hooks and Dilators



13-111  
BOSE  
165 mm



13-112  
BOSE  
165 mm



13-113 - 115  
180 mm



13-114  
blunt



13-115  
stumpf/blunt



13-116  
FINSEN  
50 mm



13-117  
FINSEN  
70 mm



13-118  
TROUSSEAU  
120 mm



13-119  
LABORDE  
125 mm



13-120  
LABORDE  
strong pattern  
135 mm



13-121  
Cleaning Brush  
for tracheal tubes  
285 mm

# Vascular Spatulas

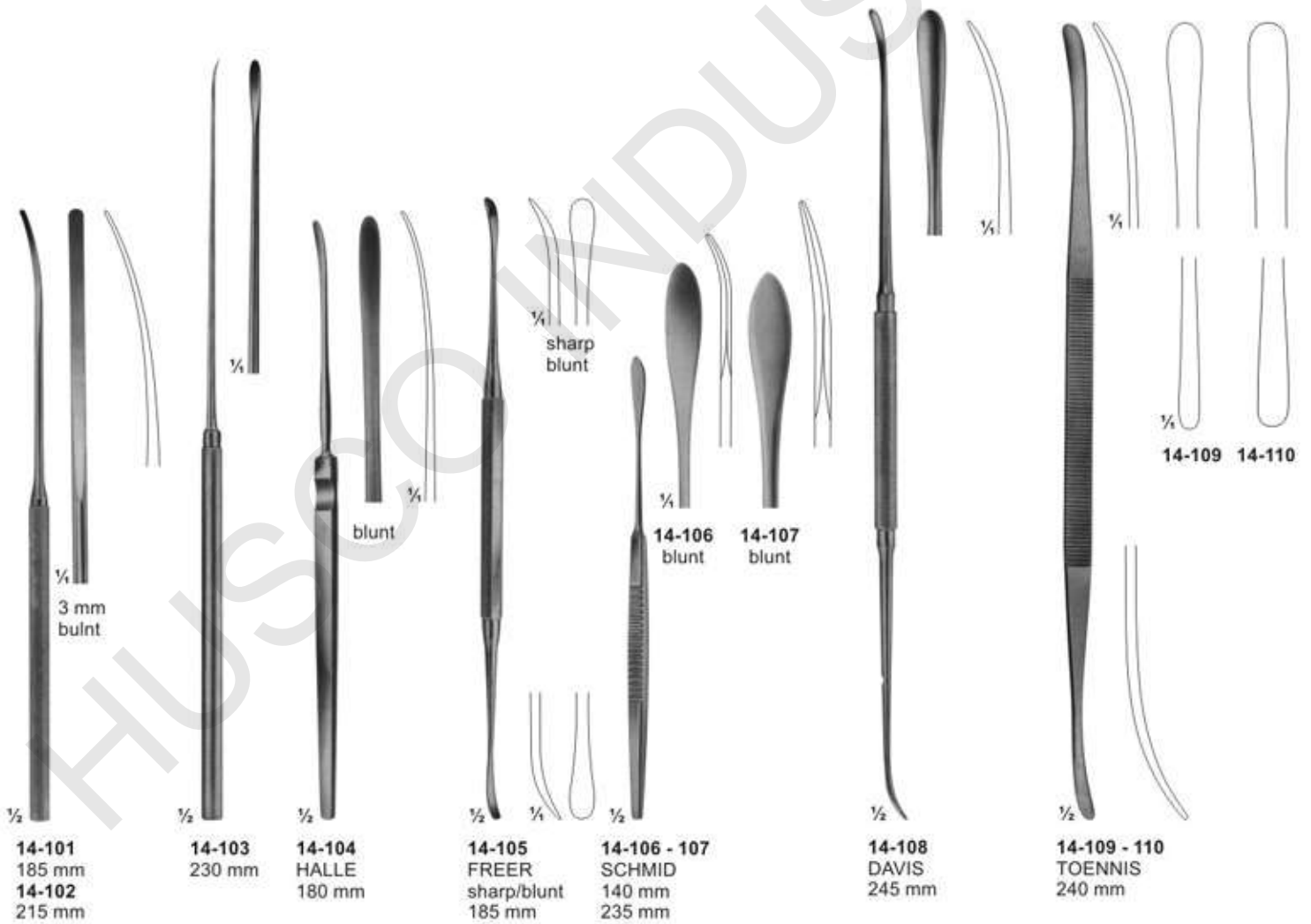

# ATRAUMATA Forceps

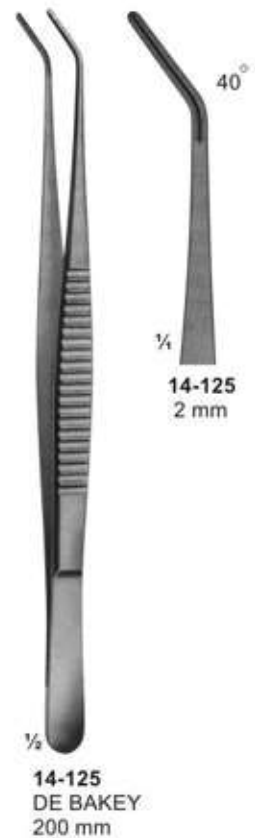
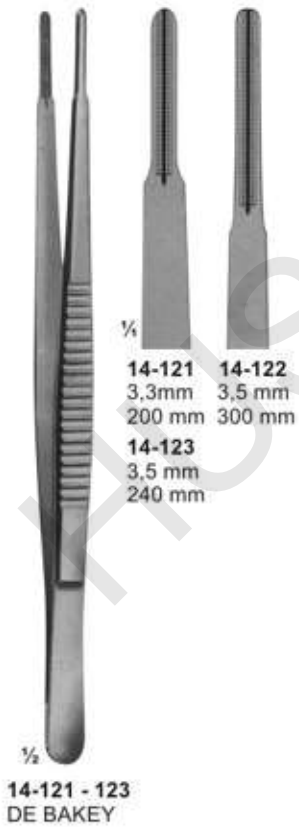
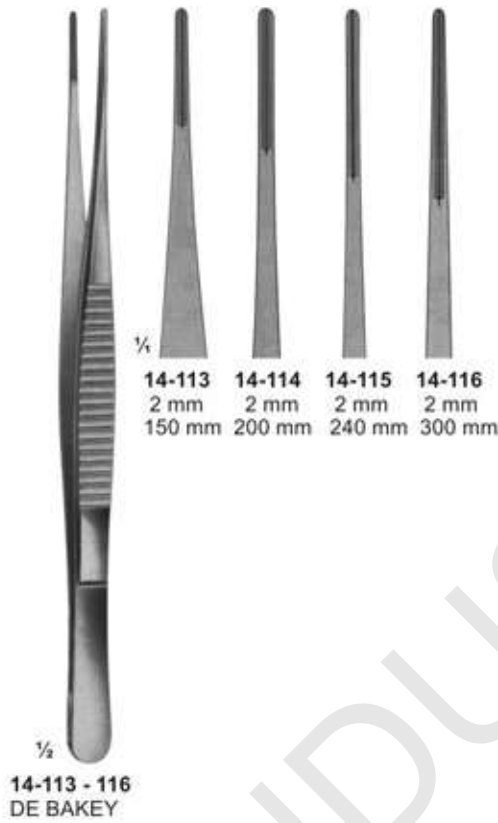
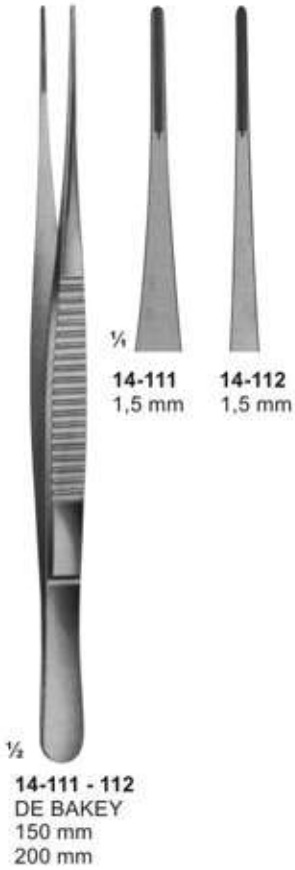

**ATRAUMATA**

**Anastomosis- and Multi- Purpose- Clamps- Pediatric types**

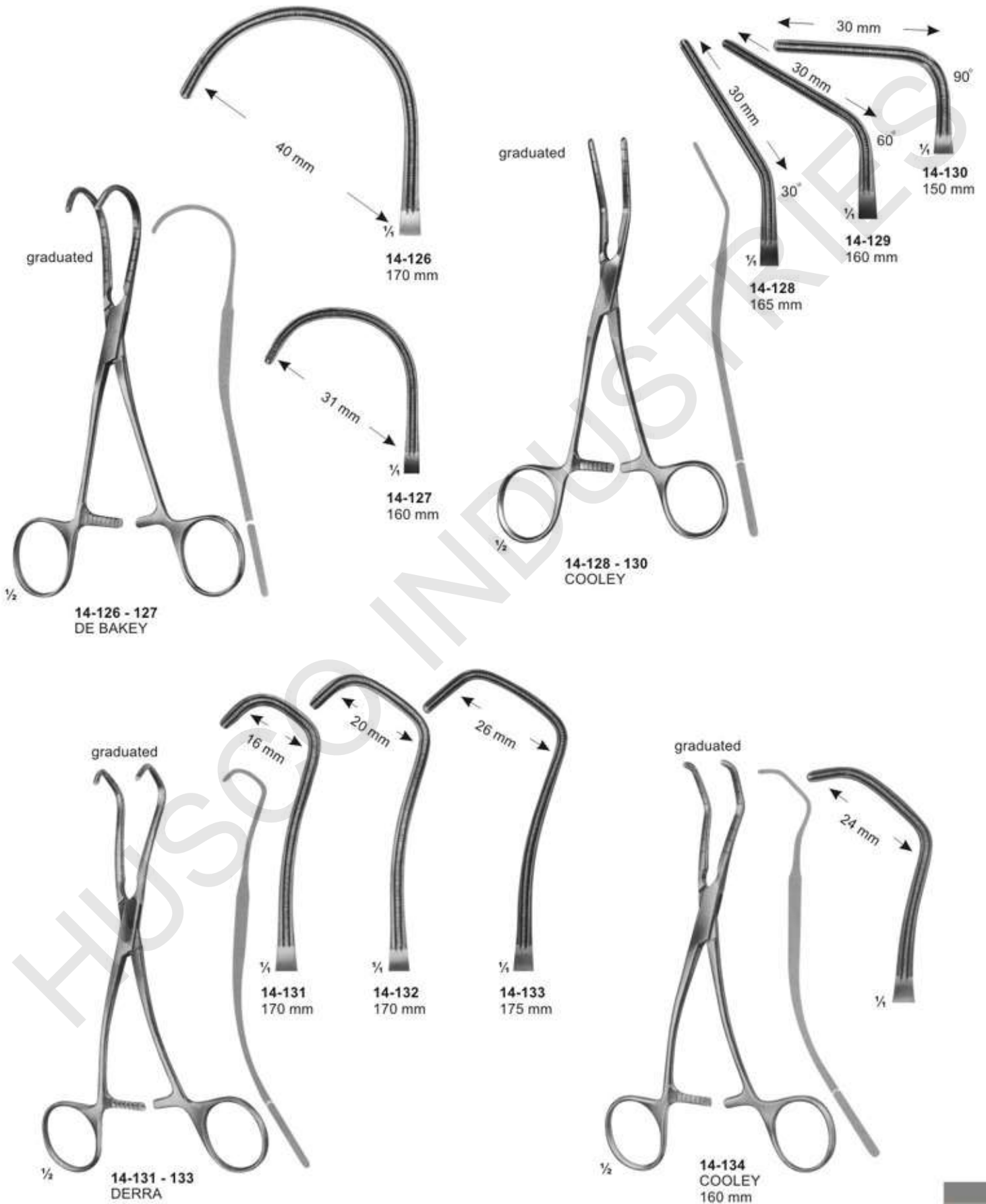

**ATRAUMATA**  
Coarctation Clamps, Patent-Ductus & Peripheral-Vascular Clamps

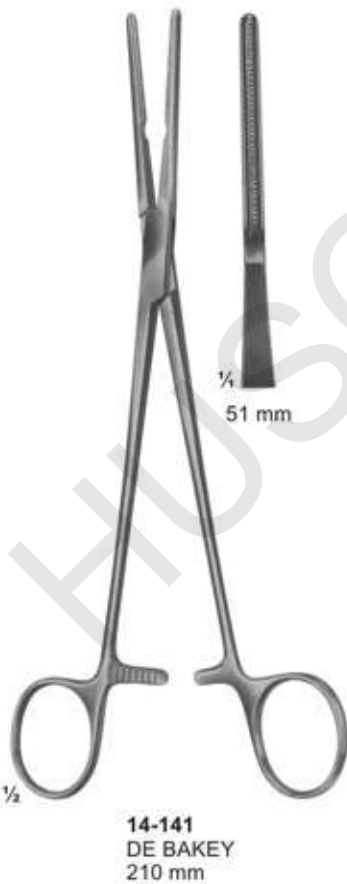

## Aorta- Anastomosis Clamps

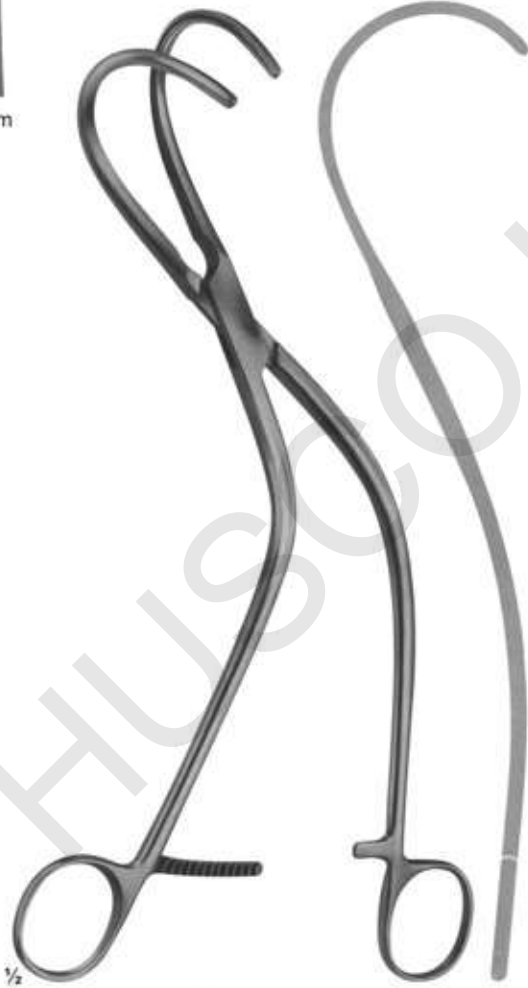
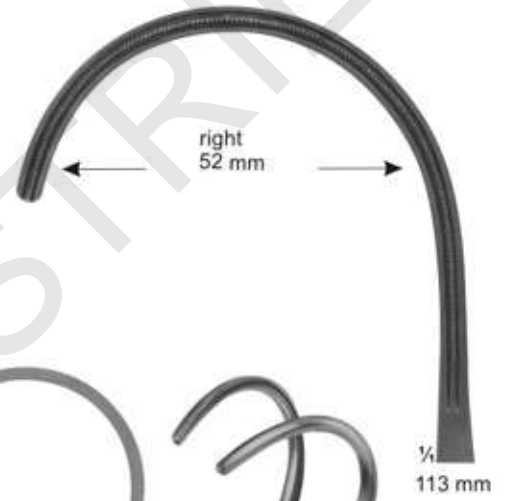
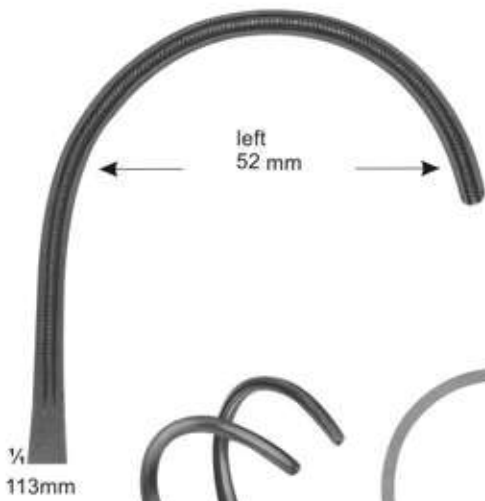

**L**  
14-144  
WEBER  
260 mm



**R**  
14-145  
WEBER  
260 mm

# Multi- Purpose-Clamps



14-146 - 149  
DE BAKEY



|                 |        |        |        |        |
|-----------------|--------|--------|--------|--------|
| Total Length:   | 230 mm | 280 mm | 305 mm | 240 mm |
| Length of jaws: | 85 mm  | 100 mm | 135 mm | 93 mm  |



14-150 - 153  
DE BAKEY

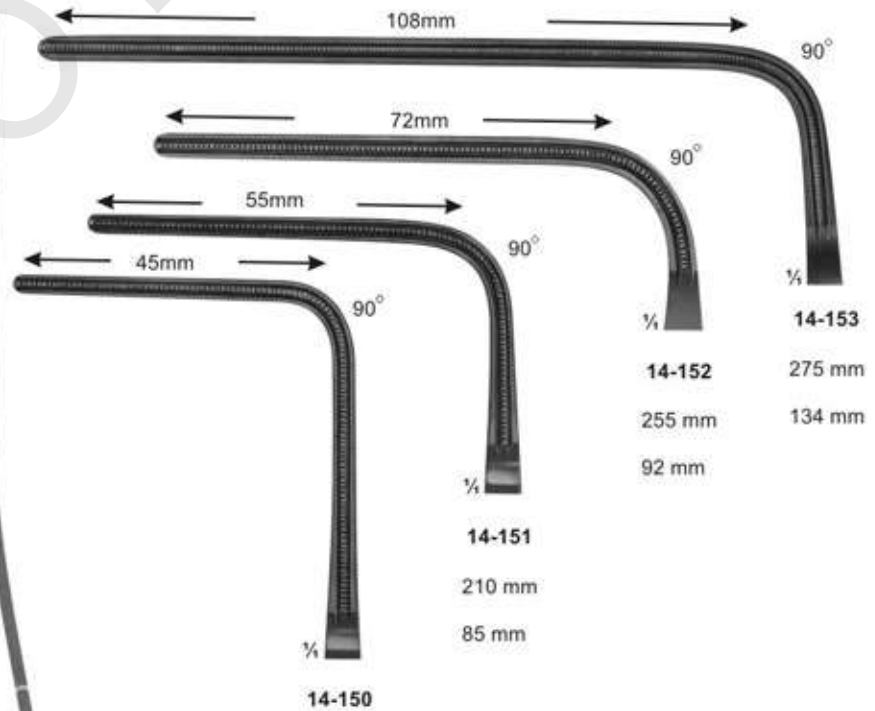

|                 |        |
|-----------------|--------|
| Total Length:   | 225 mm |
| Length of jaws: | 93 mm  |



## Sternum Instruments and Rib Shears



**14-154**  
SCHUMACHER  
Sternum shears  
210 mm



**14-155**  
LEBSCHE  
Sternum chisel  
200 mm



**14-156**  
230 mm



**14-157**  
COLLIN  
195 mm



**14-158**  
GLUCK  
190 mm



**14-159**  
BETHUNE  
340 mm



**14-160**  
BRUNNER  
Universal pattern  
340 mm



**14-161**  
GIERTZ-STILLE  
250 mm

## Rib Spreaders



**14-162**  
FINOCHIETTO  
Blades  
18X21 mm



**14-163**  
HERTZLER  
Blades  
20X25 mm

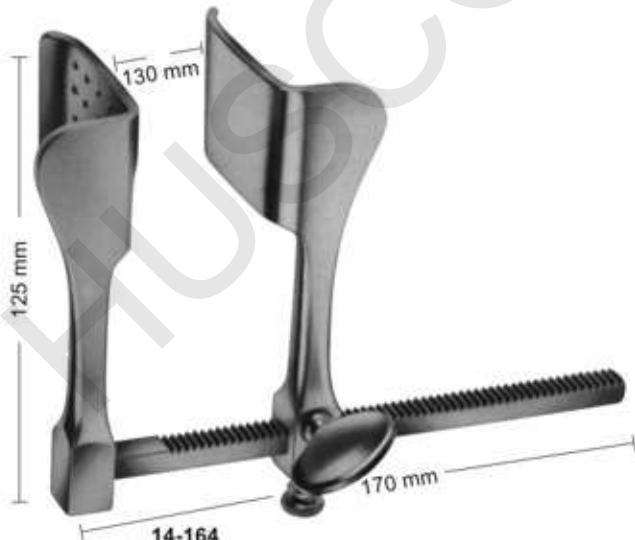

**14-164**  
TUFFIER  
Blades  
43X53 mm

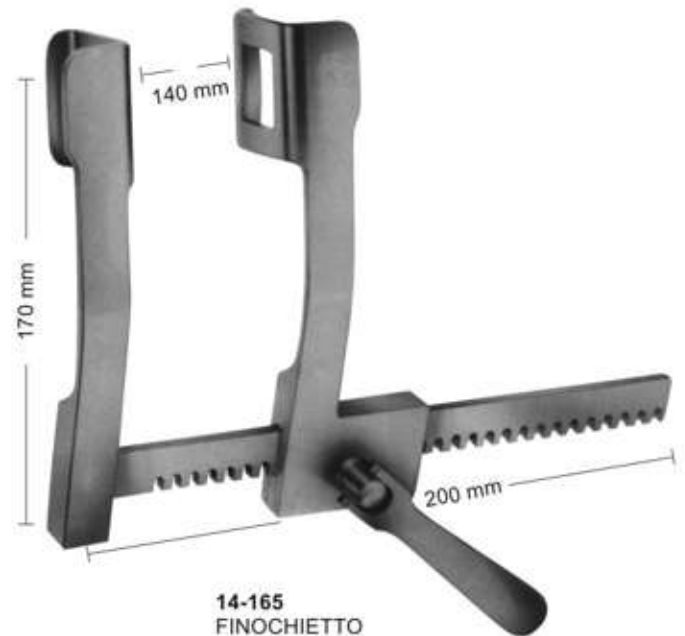

**14-165**  
FINOCHIETTO  
Blades  
36X45 mm

## Rib Spreaders-and Contractors



**14-166**  
**SELLORS**  
Rib spreader and contractor  
with swivel blades  
200 mm



**14-167**  
**BAILEY**  
150 mm



**14-168**  
for children

**14-169**  
for adults

**14-168 - 169**  
**BAILEY**  
200 mm

# Punches

**130°** upwards cutting

**15-101**  
1 mm



KERRISON - JACOBY

FERRIS-SMITH-KERRISON

**15-102**  
2 mm



**15-103**  
3 mm



**15-104**  
4 mm



**15-105**  
5 mm

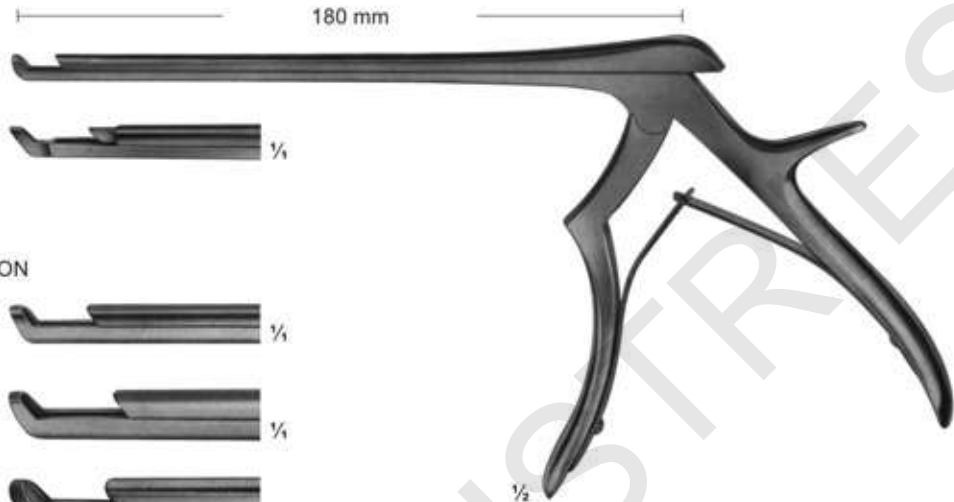

15-101 - 105

**90°** upwards cutting

KERRISON - JACOBY

**15-106**  
1 mm



**15-107**  
2 mm



FERRIS-SMITH-KERRISON

**15-108**  
3 mm



**15-109**  
4 mm



**15-110**  
5 mm

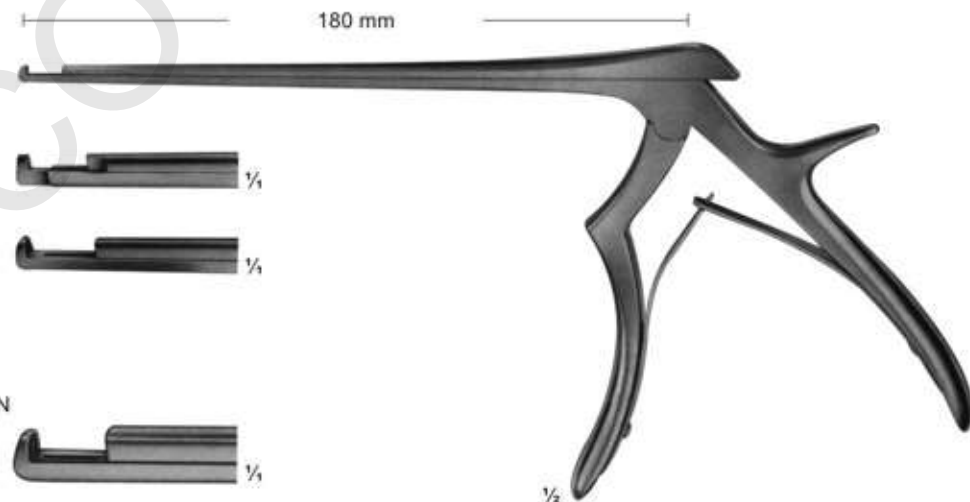

15-106 - 110

# Punches

90° upwards cutting

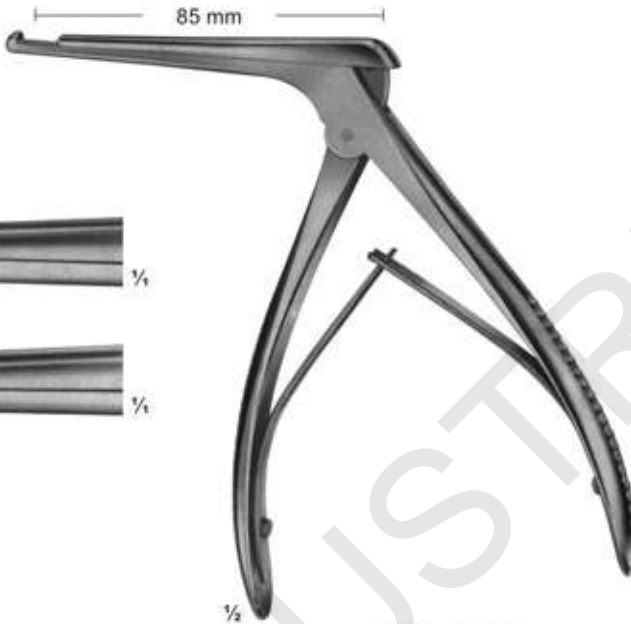

15-111  
4 mm



15-112  
5 mm



15-111 - 15-112  
KERRISON

90° upwards cutting

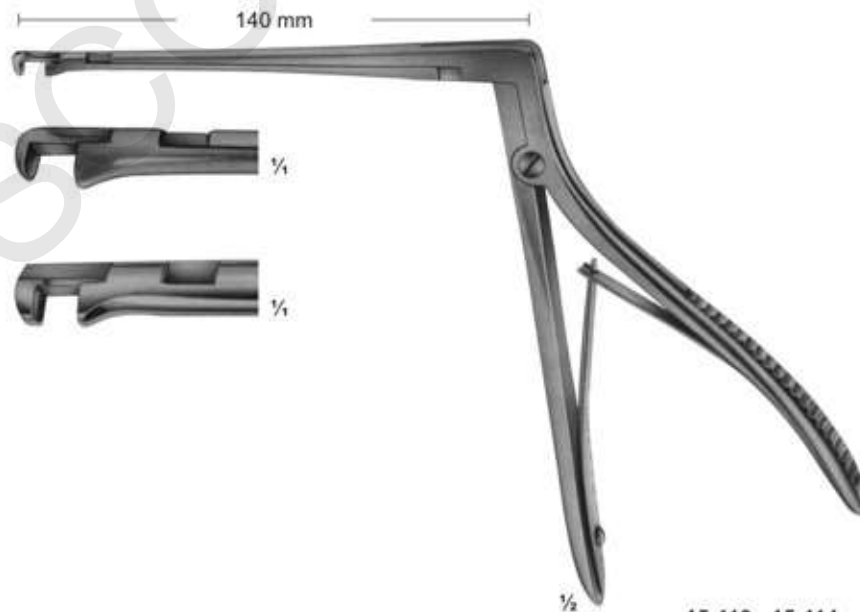

15-113  
3,3 mm



15-114  
4,0 mm



15-113 - 15-114  
HAJEK-KOFLER

# Rongeurs

## LOVE-GRUENWALD

15-115  
2 X 10 mm

15-116  
3 X 10 mm

SPURLING  
15-117  
4 X 10 mm



15-115 - 15-117

15-118  
2 mm

15-119  
3 mm

15-120  
4 mm

15-121  
5 mm

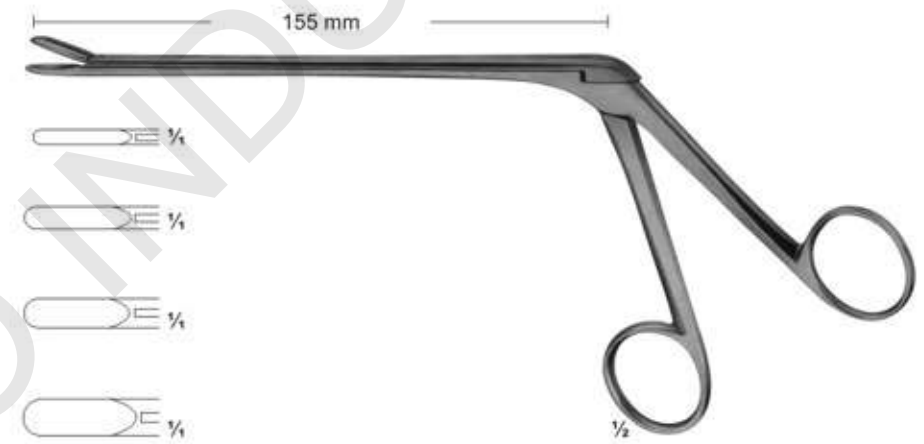

15-118 - 15-121  
CASPAR

150°

15-122  
2 mm

15-123  
3 mm

15-124  
4 mm

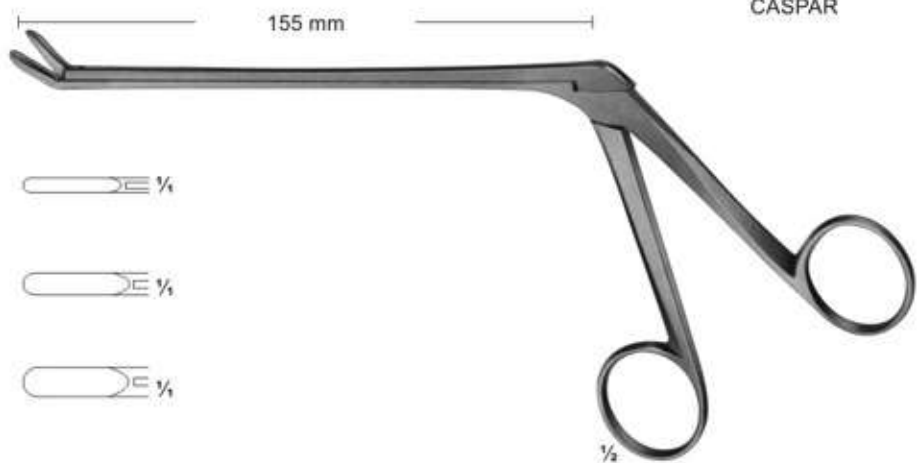

15-122 - 15-124  
CASPAR

# Rongeurs

Angled positions for rongeurs

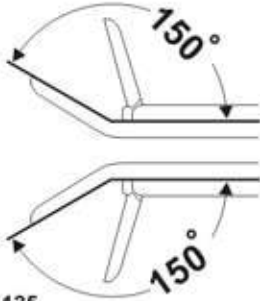

15-125  
3,0 mm

15-126  
3,6 mm

15-127  
4,2 mm

15-128  
4,8 mm

15-129  
5,8 mm

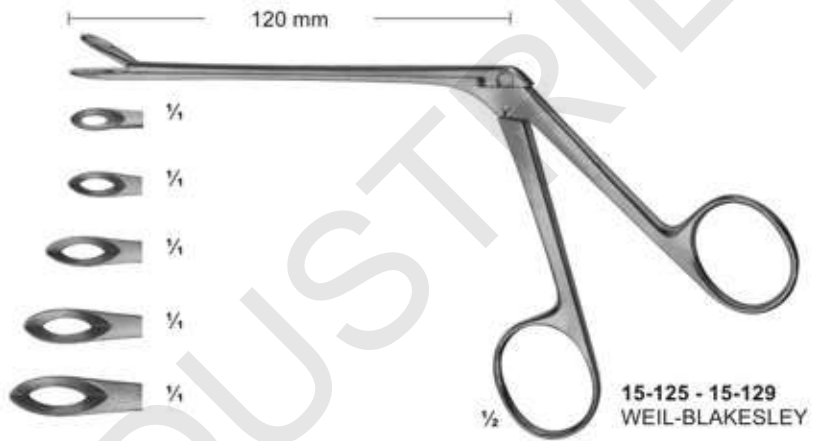
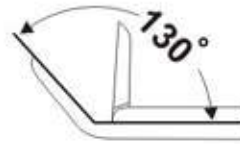
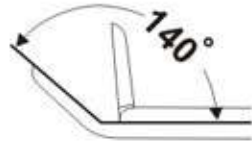

130°

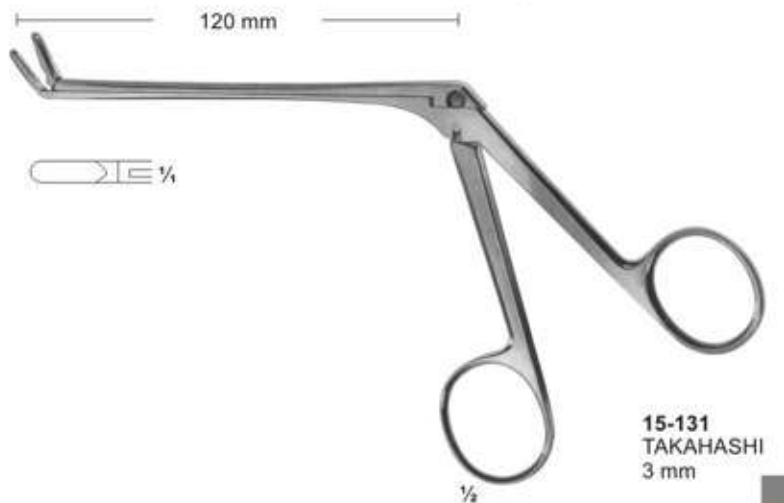

# Rongeurs

**150°**

Lower part of jaws movable

**15-132**  
2 mm

**15-133**  
3 mm

**15-134**  
4 mm



**15-132 - 15-134**  
CASPAR

| Length of shaft<br>140 mm | Length of shaft<br>160 mm | Length of shaft<br>185 mm | size of jaws |
|---------------------------|---------------------------|---------------------------|--------------|
| <b>15-135</b>             | <b>15-140</b>             | <b>15-145</b>             | 2 X12 mm     |
| <b>15-136</b>             | <b>15-141</b>             | <b>15-146</b>             | 3 X12 mm     |
| <b>15-137</b>             | <b>15-142</b>             | <b>15-147</b>             | 4 X14 mm     |
| <b>15-138</b>             | <b>15-143</b>             | <b>15-148</b>             | 5 X14 mm     |
| <b>15-139</b>             | <b>15-144</b>             | <b>15-149</b>             | 6 X16 mm     |



**15-135 - 15-149**  
CASPAR

**150°**

| Length of shaft<br>140 mm | Length of shaft<br>160 mm | Length of shaft<br>185 mm | size of jaws |
|---------------------------|---------------------------|---------------------------|--------------|
| <b>15-150</b>             | <b>15-153</b>             | <b>15-156</b>             | 3 X12 mm     |
| <b>15-151</b>             | <b>15-154</b>             | <b>15-157</b>             | 4 X14 mm     |
| <b>15-152</b>             | <b>15-155</b>             | <b>15-158</b>             | 5 X14 mm     |



**15-150 - 15-158**  
CASPAR



# Rongeurs

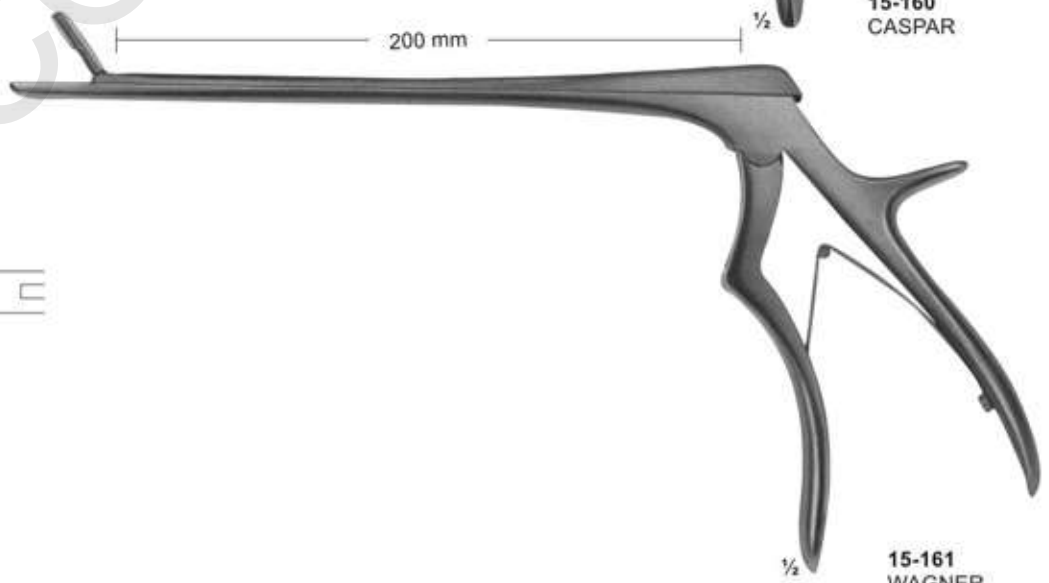
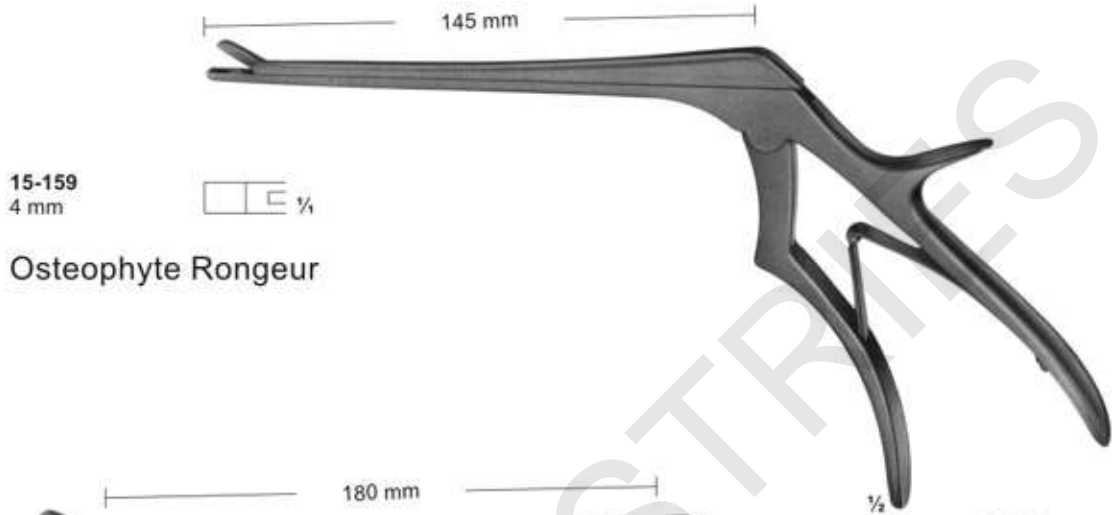

## Elevators and Bone Levers

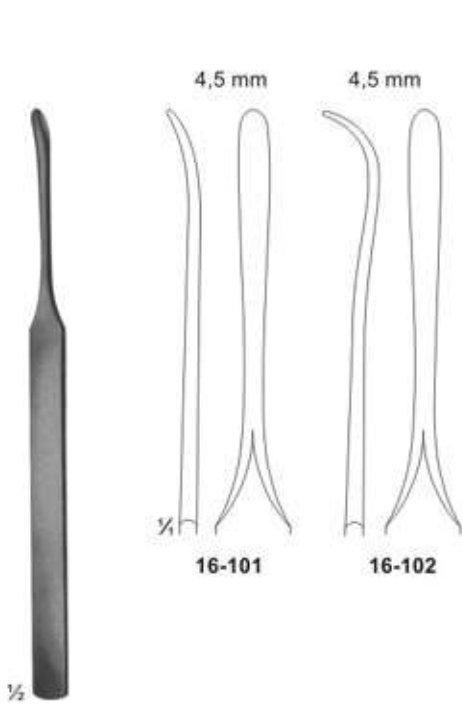

**16-101 - 102**  
KONIG  
155 mm



**16-103**  
WILLIGER  
165 mm

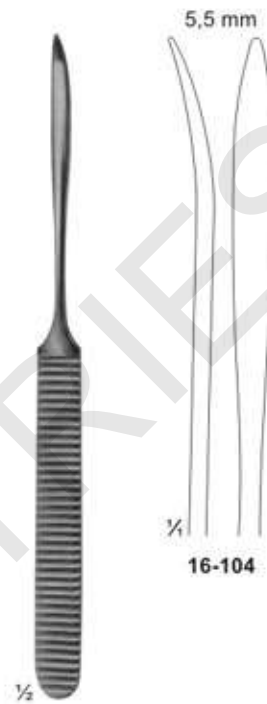

**16-104**  
WILLIGER  
170 mm

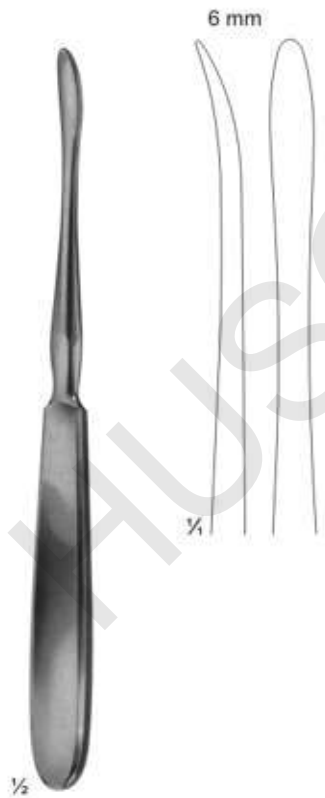

**16-105**  
QUERVAIN  
195 mm

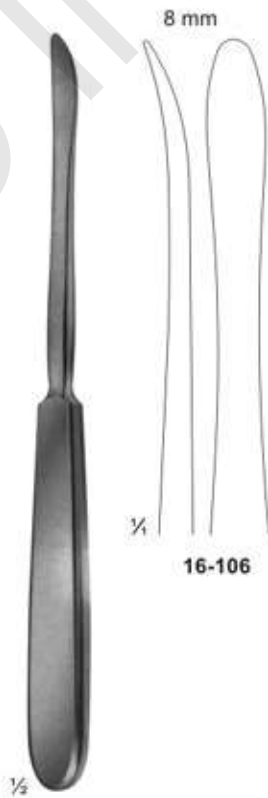

**16-106 - 107**  
LANGENBACK  
195 mm

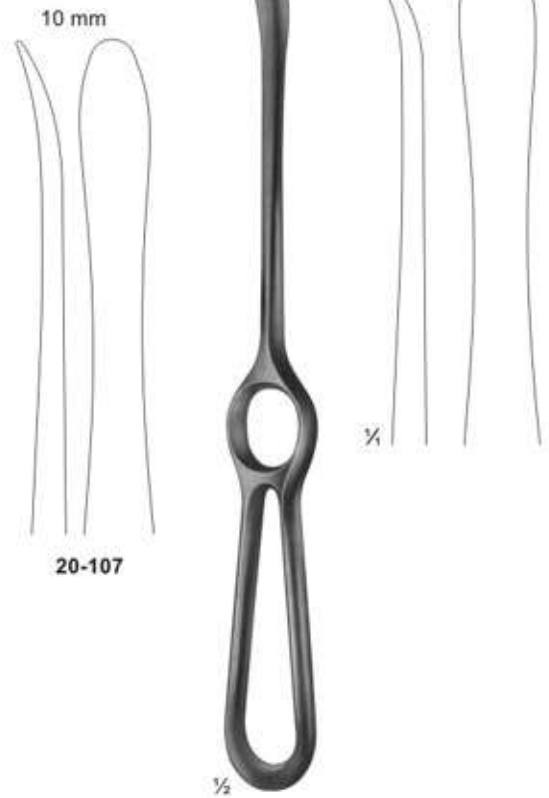

**16-108**  
LANGENBACK  
230mm

**Bone Levers**



16-109  
LANE TRETHOWAN  
215mm

16-110  
LANE  
255mm

16-111  
LANGE-HOHMANN  
250mm

16-112 - 113  
LANGE-HOHMANN modif.  
16-112 265mm  
16-113 280mm

# Raspatories



**16-114**  
PARTSCH  
150 mm



**16-116**  
PARTSCH mod. LANGE  
145 mm



**16-117**  
MC KENTY  
155 mm

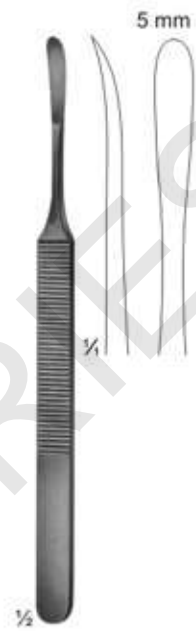

**16-118**  
KOENIG  
155 mm

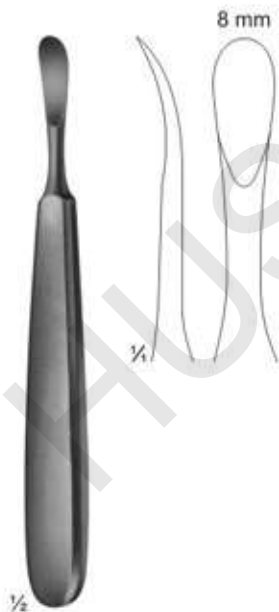

**16-119**  
TRELAT  
150 mm

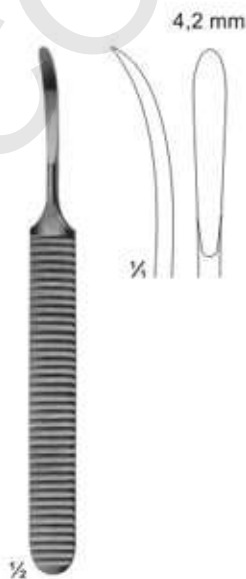

**16-120**  
WILLIGER  
140 mm



**16-121**  
WILLIGER  
160 mm

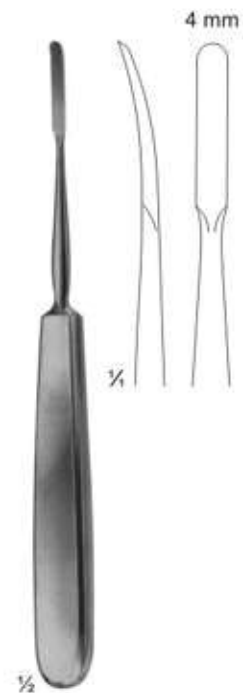

**16-122**  
JOSEPH  
170 mm

## Bone File and Rasps

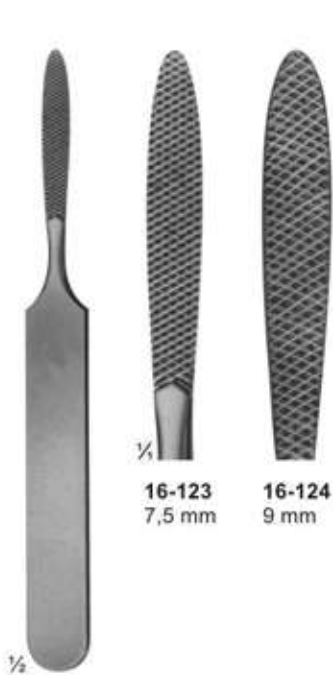

16-123  
7,5 mm

16-124  
9 mm

16-123  
JOSEPH  
fine, chequered

16-124  
coarse, chequered  
165 mm

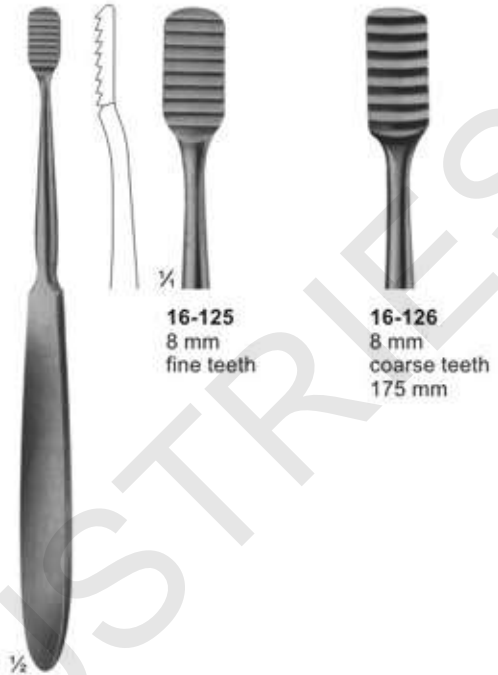

16-125  
8 mm  
fine teeth

16-126  
8 mm  
coarse teeth  
175 mm

16-125 - 16-126  
LEWIS



16-127  
9 mm

16-127  
MALTZ  
down stroke  
180 mm



16-128  
9 mm

16-129  
9 mm

16-128 - 16-129  
AUFRICHT  
up stroke  
16-129  
down stroke  
220 mm



16-130  
6,5 mm

16-130  
GALLAHER  
190 mm

**Bone Currettes**



**16-131**  
JACOBSON  
140 mm



**16-132**  
MARTINI  
140 mm



**16-133**  
MARTINI  
140 mm



**16-134**  
WILLIGER  
145 mm

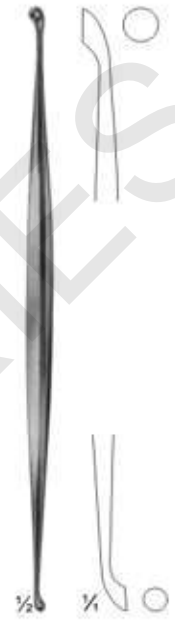

**16-135**  
JANSEN  
160 mm



**16-136**  
BARTH  
180 mm



**16-137**  
VOLKMANN  
130 mm



**16-138**  
VOLKMANN  
145 mm



**16-139**  
VOLKMANN  
170 mm

**Mallets** Weights refer to the heads of the mallets  
**Hammer** Die Gewichtsangaben beziehen sich auf den Kopf des jeweiligen Hammers



17-101  
 MEAD  
 185 g  
 with interchangeable  
 plastic disks  
 190 mm  
 17-102  
 pair of spare disks



17-103  
 140 g  
 with interchangeable  
 plastic disks  
 185 mm  
 17-104  
 pair of spare disks



17-105  
 COTTLE  
 140 g  
 1 Side Flat  
 1 Side convex  
 185 mm



17-106  
 165 g  
 lead filled head  
 190 mm

# Osteotomes, Chisels and Gouges



17-107  
MANNERFELT  
Gouge  
155 mm

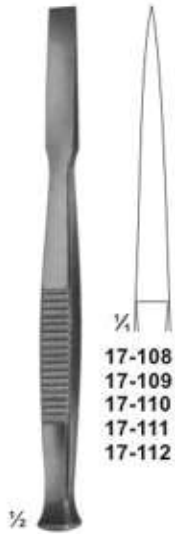

17-108 - 112  
Osteotomes  
140 mm

- 17-108 4 mm
- 17-109 6 mm
- 17-110 8 mm
- 17-111 10 mm
- 17-112 12 mm



17-113 - 117  
Chisels  
140 mm

- 17-113 4 mm
- 17-114 6 mm
- 17-115 8 mm
- 17-116 10 mm
- 17-117 12 mm



17-118 - 122  
Gouges  
140 mm

- 17-118 4 mm
- 17-119 6 mm
- 17-120 8 mm
- 17-121 10 mm
- 17-122 12 mm



PARTSCH  
17-123 - 126  
Chisels  
140 mm

- 17-123 3 mm
- 17-124 4 mm
- 17-125 5 mm
- 17-126 6 mm



PARTSCH  
17-127 - 131  
Chisels  
170 mm

- 17-127 3 mm
- 17-128 4 mm
- 17-129 5 mm
- 17-130 6 mm
- 17-131 7 mm



PARTSCH  
17-132 - 135  
Gouges  
140 mm

- 17-132 3 mm
- 17-133 4 mm
- 17-134 5 mm
- 17-135 6 mm



PARTSCH  
17-136 - 140  
Gouges  
170 mm

- 17-136 3 mm
- 17-137 4 mm
- 17-138 5 mm
- 17-139 6 mm
- 17-140 7 mm



LUCAS  
17-141 - 142  
Chisels  
160 mm

- 17-141 4 mm
- 17-142 6 mm



LUCAS  
17-143 - 144  
Gouges  
160 mm

- 17-143 3 mm
- 17-144 5 mm



**Reposition Forceps, Bone Holding Forceps**



**17-145**  
Patella forceps  
185 mm



**17-146**  
Forceps with  
ratchet fixation  
140 mm



**17-147**  
Forceps with  
thread fixation  
170 mm



**17-148**  
Forceps with  
thread fixation  
235 mm

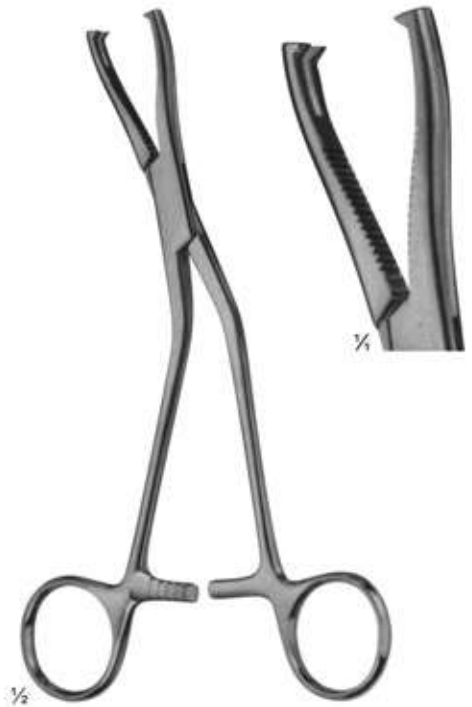

**17-149**  
DINGMANN  
185 mm

## Bone Holding Forceps & Bone Clamps



# Bone Rongeurs



**17-158**  
LUER  
150 mm



**17-159**  
LUER  
155 mm



**17-160**  
BLUMENTHAL  
155 mm

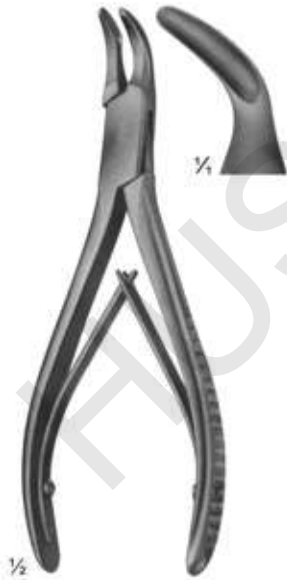

**17-161**  
BLUMENTHAL  
150 mm



**17-162 - 163**  
JANSEN  
175 mm

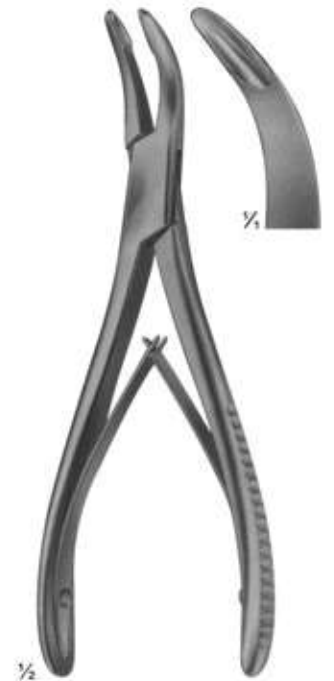

**17-164**  
BANE-HARTMANN  
175 mm

## Bone Rongeurs



**17-165**  
STILLE  
235 mm



**17-166**  
LEKSELL-STILLE  
240mm



**17-167**  
STILLE-RUSKIN  
240mm

## Bone Cutting Forceps



**17-168**  
LISTON  
curved on flat  
240 mm

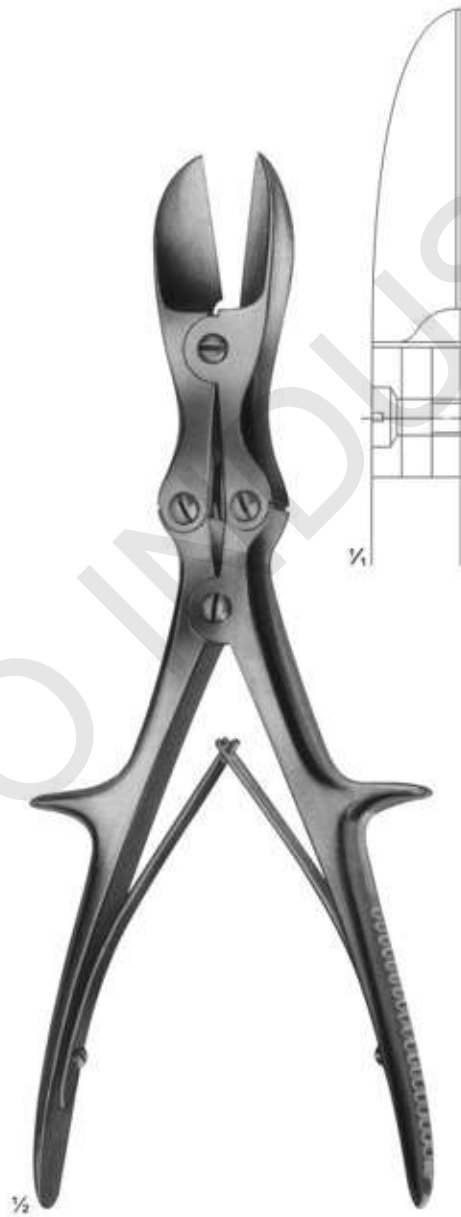

**17-169**  
LISTON  
straight  
280 mm

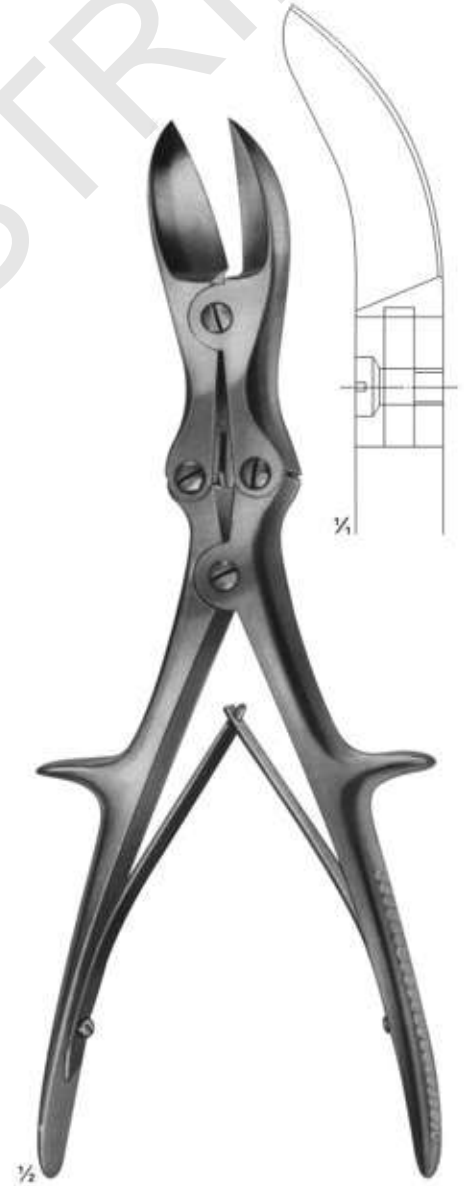

**17-170**  
LISTON  
curved on flat  
280 mm

# Wire Extension

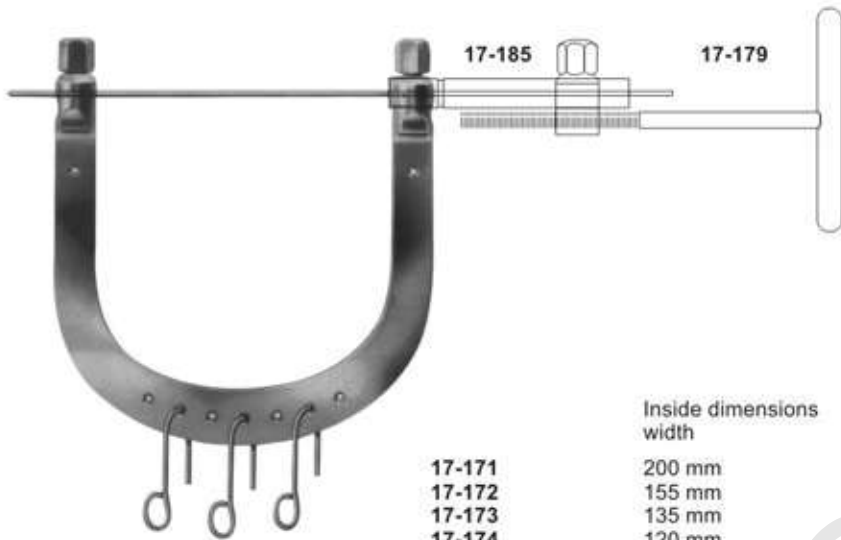

**17-171 - 17-177**  
**KIRSCHNER**  
 Wire traction bows,  
 to be used with  
 KIRSCHNER-wires  
 up to 2.5 mm diam.,  
 With 3 hooks,  
 stainless steel

|        | Inside dimensions<br>width | depth  |                       |
|--------|----------------------------|--------|-----------------------|
| 17-171 | 200 mm                     | 155 mm | for the hip           |
| 17-172 | 155 mm                     | 155 mm | for the femur         |
| 17-173 | 135 mm                     | 130 mm | for the knee          |
| 17-174 | 120 mm                     | 120 mm | for the knee          |
| 17-175 | 105 mm                     | 100 mm | for the knee          |
| 17-176 | 95 mm                      | 110 mm | for the calcaneus     |
| 17-177 | 95 mm                      | 70 mm  | for the arm and elbow |



**17-178**  
 Wrench, double - ended,  
 for wire traction bows



**17-179**  
 Wire tightener, with  
 clamping jaws



|           |             |
|-----------|-------------|
| 17-182    | max. 105 mm |
| 17-183    | max. 160 mm |
| 17-184    | max. 200 mm |
| 17-182    | 80-95 mm    |
| 17-183    | 90-120 mm   |
| 17-184    | 140-170 mm  |
| diam upto |             |
| 17-182    | 1,6 mm      |
| 17-183    | 2,0 mm      |
| 17-184    | 2,5 mm      |

**17-182 - 17-184**  
**KIRSCHNER**  
 Wire traction bows, modified,  
 adjustable in width, holds wire  
 securely, with 1 hook



**17-180**  
 Traction hook only,  
 large size



**17-181**  
 Traction hook only,  
 small size



**17-185**  
 Fixation clamp, to secure clamping  
 jaws of 17-179 stainless steel

## Cerclage Instruments

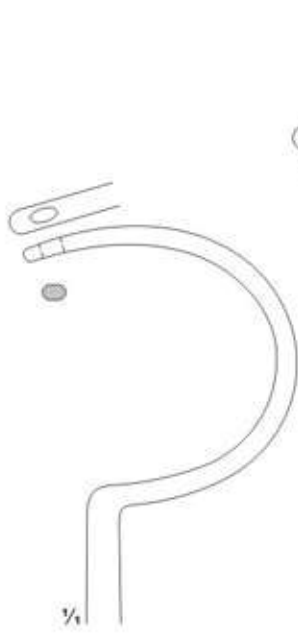

17-186  
275 mm

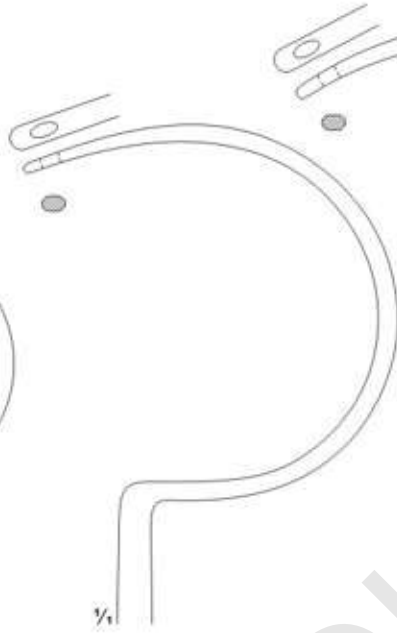

17-187  
285 mm

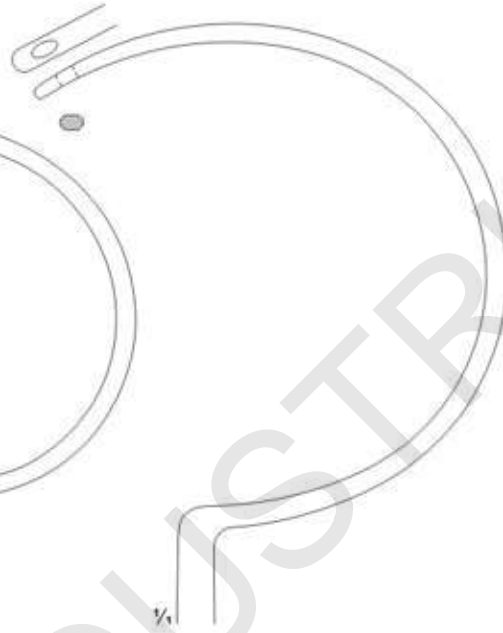

17-188  
305 mm



17-186 - 17-188  
DEMEL  
Wire guides



17-189  
240 mm

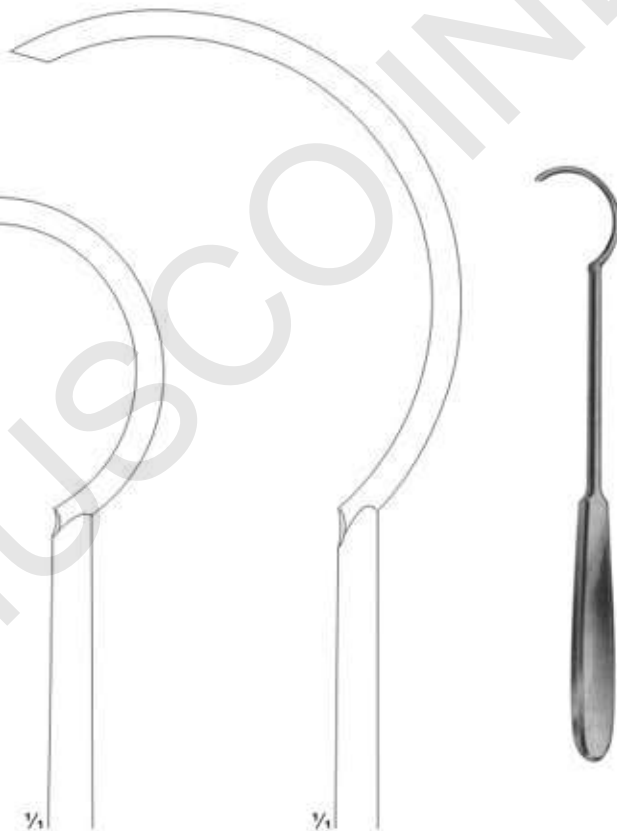

17-190  
270 mm



17-191  
225 mm

# Wire Holding forceps, Wire Tightening Pliers, Flat-nosed Pliers DUROGRIP with Hard Metal Inserts



**17-192**  
DUROGRIP  
Holding forceps for cerclage wire, with lateral jaws to avoid wire slipping off  
170 mm



**17-193**  
DUROGRIP  
Wire, tightening pliers,  
Ligature pliers  
150 mm

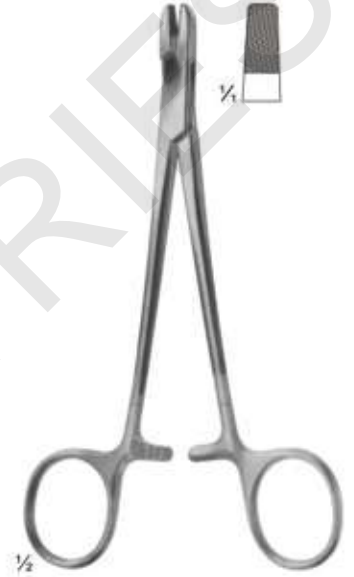

**17-194**  
DUROGRIP  
Wire, tightening pliers,  
Ligature pliers  
150 mm

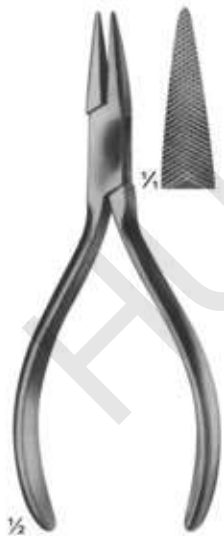

**17-195**  
with serrated jaws  
140 mm



**17-196**  
one jaw smooth,  
one jaw serrated  
140 mm



**17-197**  
with serrated jaws  
**17-198**  
with longitudinal and  
transversal grooves  
170 mm



**17-199**  
190 mm



## Wire Holding forceps, Flat-nosed Pliers, Pliers for bending and cutting wires



17-200  
130 mm

17-201  
180 mm



17-200 - 17-201  
Extraction pliers  
for boring wires



17-202  
Flat-nosed pliers,  
parallel  
185 mm

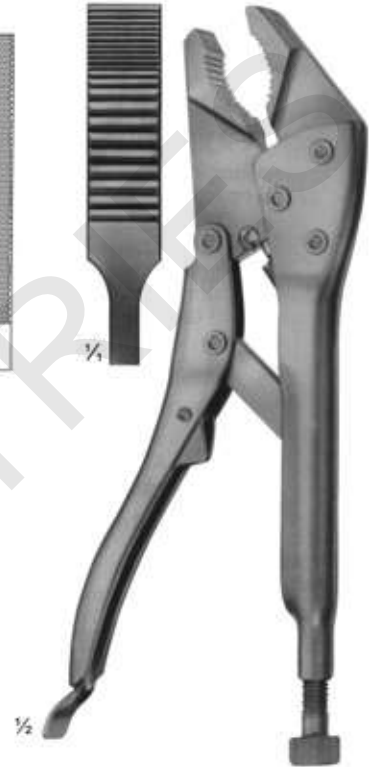

17-203  
Vise grip  
200 mm



17-204  
Round Pliers  
180mm



17-204



17-204



17-205



17-206



17-207

17-205 145 mm  
17-206 180 mm  
17-207 180 mm  
Extraction pliers for wires



17-208  
Bending pliers  
for wires up to  
1.8 mm diam.

# Wire Cutters and wire Cutting Scissors DUROTIP with Carbide Cutting Edges



**17-209**  
ANGLE  
130 mm

for soft wire  
up to diam.  
for hard wire  
up to diam.

0,5 mm  
0,3 mm

**17-210**  
DUROTIP  
ANGLE  
130 mm

0,6 mm  
0,4 mm

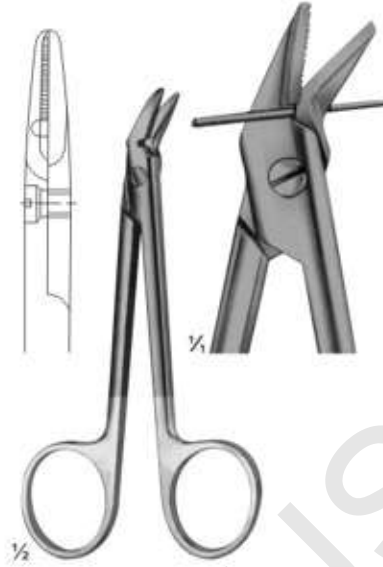

**17-211**  
120 mm

for soft wire  
up to diam.  
for hard wire  
up to diam.

1,2 mm  
0,8 mm

**17-212**  
DUROTIP  
120 mm

1,2 mm  
0,8 mm

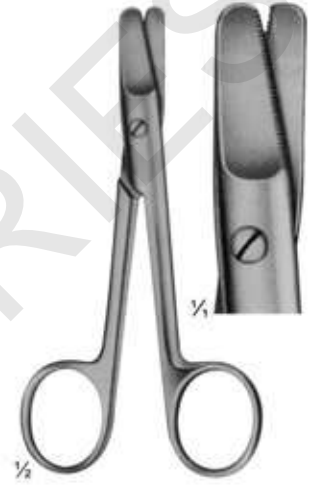

**17-213**  
HARVEY  
125 mm

0,4 mm  
0,3 mm



**17-214**  
150 mm

for soft wire  
up to diam  
for hard wire  
up to diam

1,5 mm  
1,0 mm



**17-215**  
160 mm

1,5 mm  
1,2 mm



**17-216**  
140 mm  
DUROTIP  
1,5 mm

1,0 mm

## Wire Cutting Pliers, Lateral Cutting Action



**17-217**  
180 mm

for soft wire  
up to diam. 2,0 mm  
For hard wire 1,5 mm  
up to diam  
specially hardened  
cutting edges, front  
and lateral cutting  
action



**17-218**  
REILL  
175 mm

for soft wire  
up to diam. 2,0 mm  
For hard wire 1,6 mm  
up to diam  
specially hardened  
cutting edges, for  
cutting off wires close  
to the bone



**DUROTIP**

**17-219**  
235 mm

for soft wire  
up to diam. 3,0 mm  
For hard wire 2,2 mm  
up to diam

# Wire Cutting Pliers, Lateral and Front Cutting Action



**17-220**  
240 mm

for soft wire up to diam. 2,0 mm  
For hard wire up to diam. 1,6 mm



**17-221**  
145 mm

for soft wire up to diam. 1,5 mm  
For hard wire up to diam. 1,0 mm



**17-222**  
145 mm

for soft wire up to diam. 2,0 mm  
For hard wire up to diam. 1,5 mm



**17-223**  
220 mm

for soft wire up to diam. 3,5 mm  
For hard wire up to diam. 2,5 mm

**Wire Cutting Pliers**



**17-224**  
320 mm

for soft wire  
up to diam. 3,0 mm  
For hard wire  
up to diam 3,0 mm



Cutter for cutting off  
KIRSCHNER wires,  
Tibia head screws,  
bolts, pins, up to 3 mm diam.



**DUROTIP**

**17-225**  
Cutter for cutting off  
KIRSCHNER wires,  
Tibia head screws,  
bolts, pins, up to 6 mm diam.  
470 mm

## Finger Nail Instruments

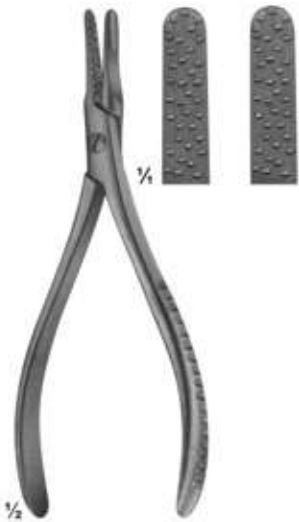

**17-226**  
Nail extracting  
forceps  
135 mm



**17-227**  
Nail extracting  
forceps  
145 mm



**17-228**  
Finger nail drill  
with 3 drill points

Drill points only

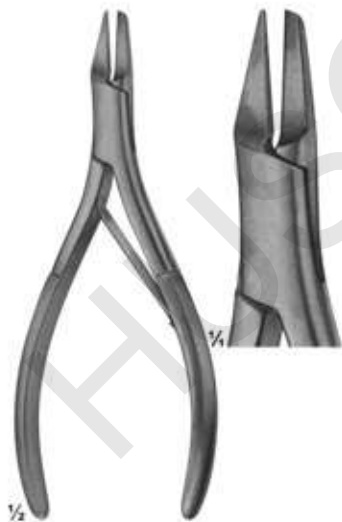

**17-231**  
Nail splitting  
forceps  
135 mm



**17-232**  
SYSTRUNK  
Scissors, for splitting  
finger nails  
130 mm



**17-233**  
Finger ring saw  
150 mm

Spare blade  
17-234

## Plaster Shears



**17-235**  
STILLE-AESCULAP  
260 mm



**17-236**  
STILLE-AESCULAP  
360 mm

## Plaster Spreader, Plaster Breakers



17-237  
HENING  
270 mm



17-238  
MOD.USA  
230 mm



17-239  
290 mm



with removable jaws



17-240 - 17-241  
WOLFF  
17-240 180 mm  
17-241 240 mm  
plaster breakers



## Vacuum Curettes for Aspiration Lipectomy, Suction Instruments



## Suction Instruments

**18-115 150mm**  
Suction handle, with vacuum regulator and finger cut-off, brass, mirror-finish chromium-plated



olive  
Ø 9 mm

**18-116 170mm**  
Suction handle, with hand regulation valve and quick-shutter, brass, mirror-finish chromium-plated



Both suction handles have bayonet fitting Olive and can be used for the suction cannulae. Ø 9 mm



**18-117**  
Trocar  
For puncturing  
170 mm



**18-118**  
Hollow needle,  
sharp  
150 mm



**18-119**  
double curved  
For general  
surgery  
230 mm



**18-120**  
For tonsillectomy,  
oral and laryngeal  
operations  
190 mm



**18-121**  
For tonsillectomy,  
oral and laryngeal  
operations  
220 mm

★ With bayonet fitting to be used with suction handles (18-115 - 18-116)

# Suction Instruments

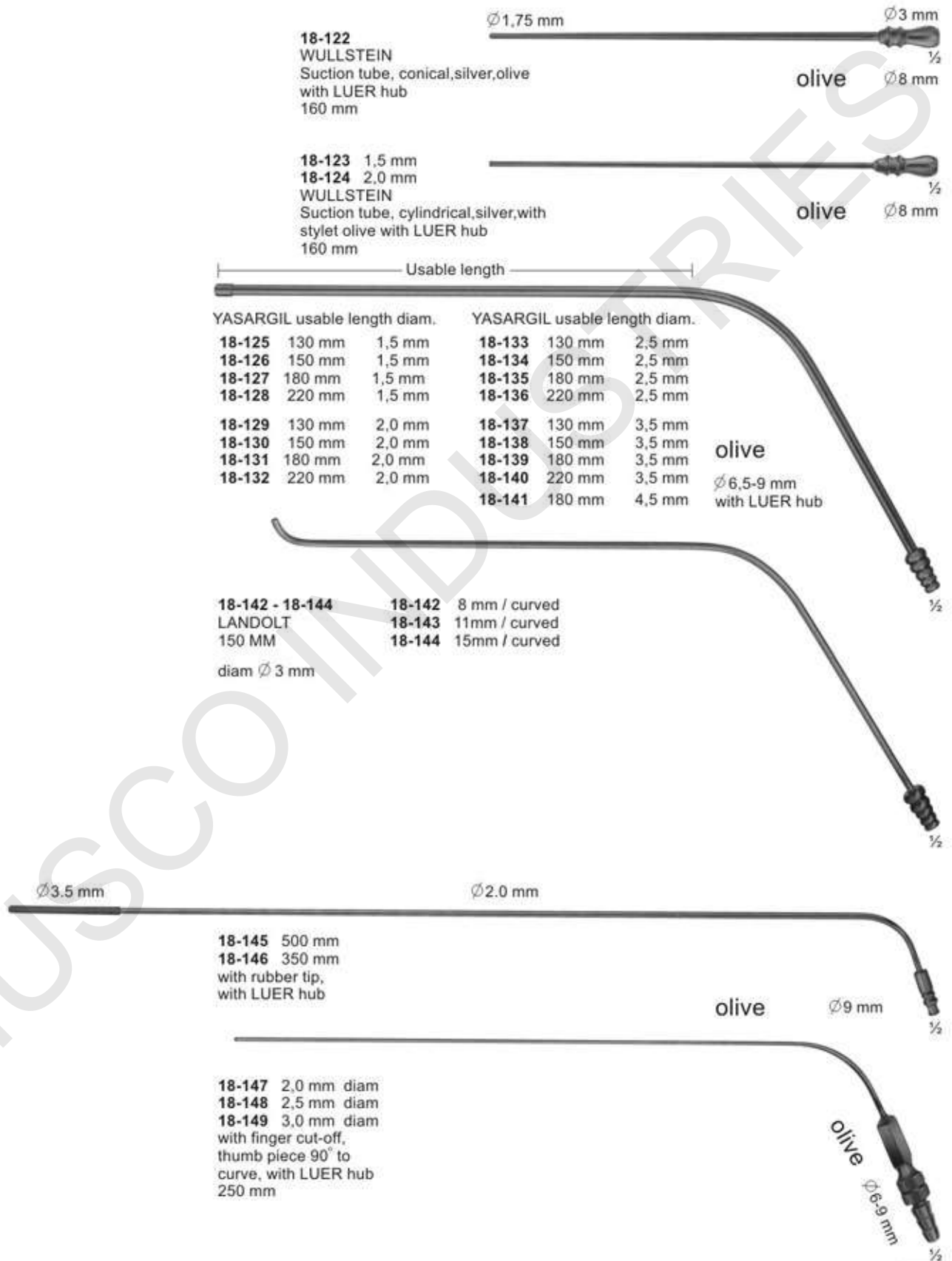

**18-122**  
WULLSTEIN  
Suction tube, conical, silver, olive  
with LUER hub  
160 mm

$\varnothing 1,75$  mm

$\varnothing 3$  mm

olive  $\frac{1}{2}$   $\varnothing 8$  mm

**18-123** 1,5 mm  
**18-124** 2,0 mm  
WULLSTEIN  
Suction tube, cylindrical, silver, with  
stylet olive with LUER hub  
160 mm

olive  $\frac{1}{2}$   $\varnothing 8$  mm

Usable length

| YASARGIL usable length diam. |               | YASARGIL usable length diam. |               |
|------------------------------|---------------|------------------------------|---------------|
| <b>18-125</b>                | 130 mm 1,5 mm | <b>18-133</b>                | 130 mm 2,5 mm |
| <b>18-126</b>                | 150 mm 1,5 mm | <b>18-134</b>                | 150 mm 2,5 mm |
| <b>18-127</b>                | 180 mm 1,5 mm | <b>18-135</b>                | 180 mm 2,5 mm |
| <b>18-128</b>                | 220 mm 1,5 mm | <b>18-136</b>                | 220 mm 2,5 mm |
| <b>18-129</b>                | 130 mm 2,0 mm | <b>18-137</b>                | 130 mm 3,5 mm |
| <b>18-130</b>                | 150 mm 2,0 mm | <b>18-138</b>                | 150 mm 3,5 mm |
| <b>18-131</b>                | 180 mm 2,0 mm | <b>18-139</b>                | 180 mm 3,5 mm |
| <b>18-132</b>                | 220 mm 2,0 mm | <b>18-140</b>                | 220 mm 3,5 mm |
|                              |               | <b>18-141</b>                | 180 mm 4,5 mm |

olive  $\varnothing 6,5-9$  mm with LUER hub

**18-142 - 18-144**  
LANDOLT  
150 MM  
diam  $\varnothing 3$  mm

**18-142** 8 mm / curved  
**18-143** 11mm / curved  
**18-144** 15mm / curved

$\varnothing 3,5$  mm

$\varnothing 2,0$  mm

**18-145** 500 mm  
**18-146** 350 mm  
with rubber tip,  
with LUER hub

olive  $\varnothing 9$  mm  $\frac{1}{2}$

**18-147** 2,0 mm diam  
**18-148** 2,5 mm diam  
**18-149** 3,0 mm diam  
with finger cut-off,  
thumb piece  $90^\circ$  to  
curve, with LUER hub  
250 mm

olive  $\varnothing 6-9$  mm  $\frac{1}{2}$

# Combined Suction and Irrigation Cannulae, Coagulation Suction Cannulae

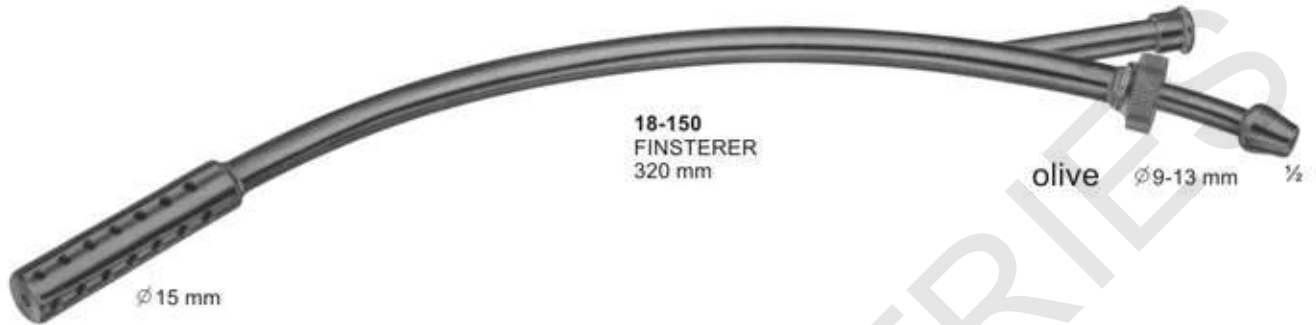

**18-150**  
FINSTERER  
320 mm

olive  $\varnothing$ 9-13 mm 1/2

$\varnothing$  15 mm



$\varnothing$  2 mm

$\varnothing$  4,5 mm

**18-151**  
YASARGIL  
LUER-LOCK cone  
200 mm

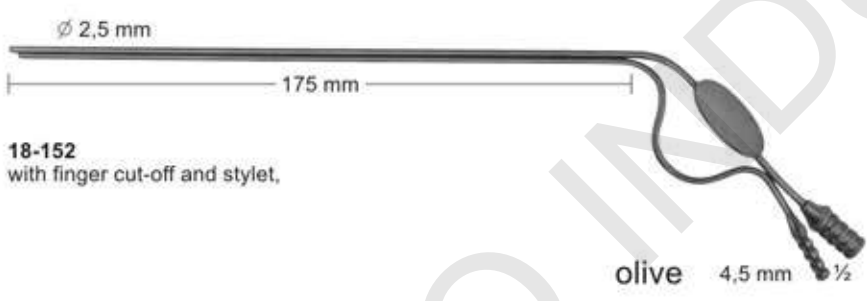

$\varnothing$  2,5 mm

175 mm

**18-152**  
with finger cut-off and stylet,

olive 4,5 mm 1/2



90 mm

**18-153 - 18-155**  
HOUSE

|               | suction tube diam. | irrigation tube Diam. |
|---------------|--------------------|-----------------------|
| <b>18-153</b> | 0,9 mm             | 0,7 mm                |
| <b>18-154</b> | 1,2 mm             | 0,9 mm                |
| <b>18-155</b> | 1,5 mm             | 1,2 mm                |

with finger cut-off and stylet, with LUER hub

$\varnothing$  4 mm olive

olive  $\varnothing$ 9-6 mm 1/2

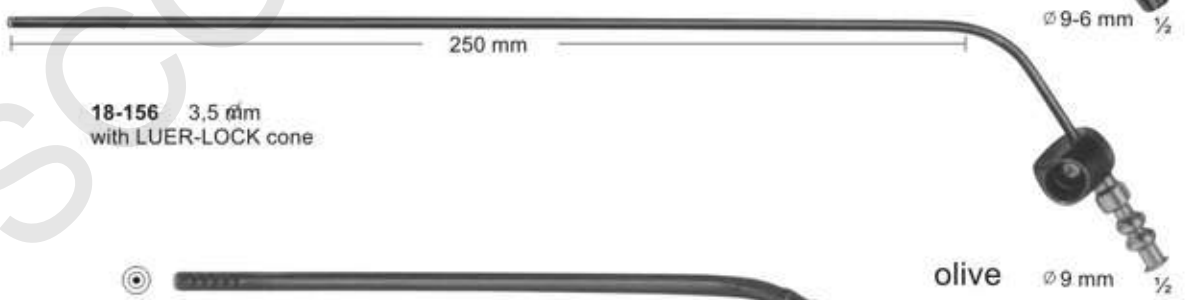

**18-156** 3,5 mm  
with LUER-LOCK cone

olive  $\varnothing$  9 mm 1/2



**18-157**  $\varnothing$  5.0 mm  
LANDOLT  
with finger cut-off and stylet, can be sterilized in an autoclave up to 3 bar (143 °C )

Connection for suction hose

$\varnothing$  7,5-12 mm olive

4 mm diam., Untarnished contact to be touched by HF-electrodes

# Suction Instruments

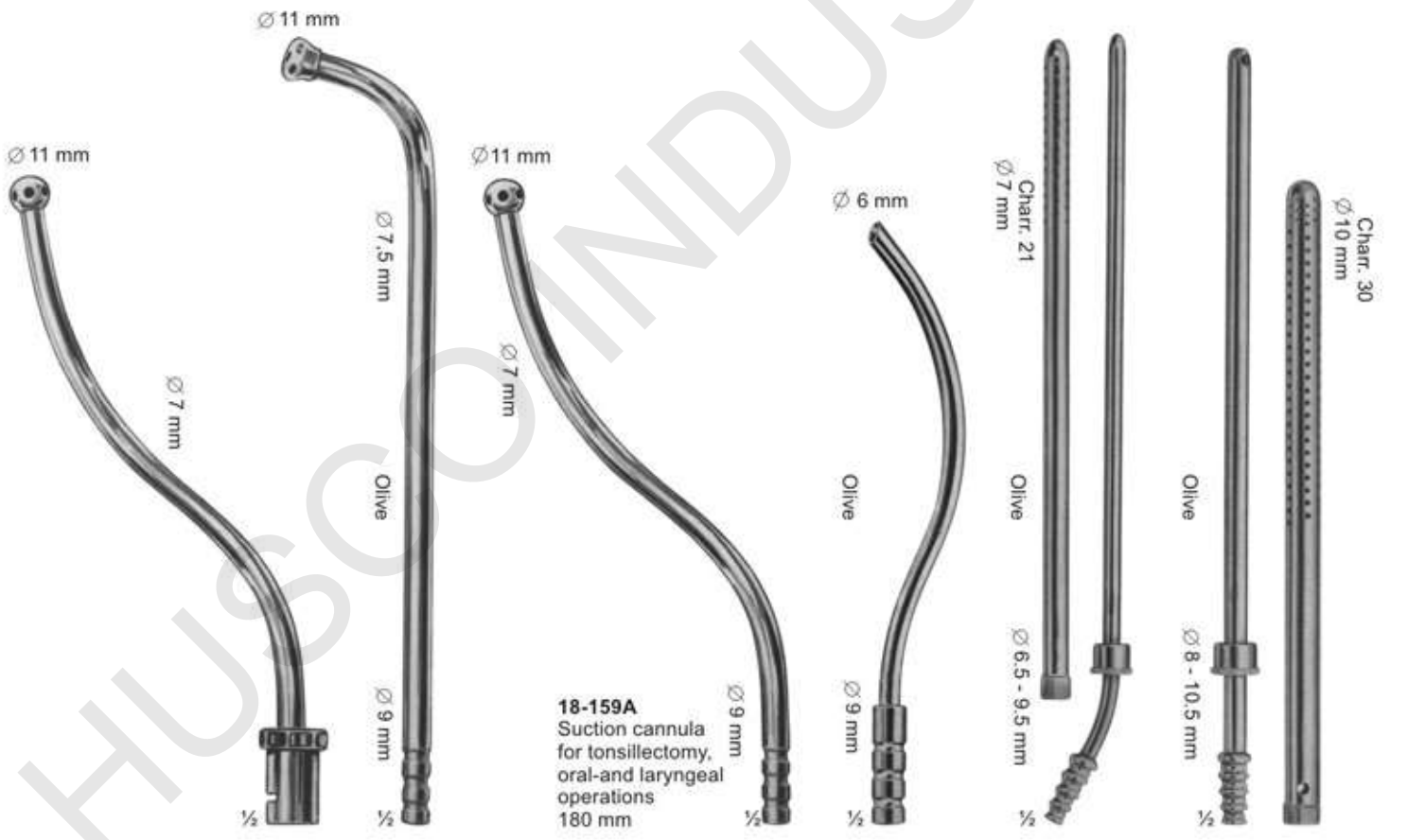

**18-158**  
For tonsillectomy,  
oral-and laryngeal  
operations  
180 mm

**18-159**  
Suction cannula  
for tonsillectomy,  
oral-and laryngeal  
operations  
220 mm

**18-159A**  
Suction cannula  
for tonsillectomy,  
oral-and laryngeal  
operations  
180 mm

**18-160**  
S-shaped blunt cannula  
for aspirating fluid from  
the excretory ducts of  
large glands and for  
keeping the operating  
area clear  
170 mm

**18-161**  
POOL  
Suction cannula,  
with outer tube  
to be screwed off  
225 mm

**18-162**  
POOL  
Suction cannula,  
with outer tube  
to be screwed off  
225 mm

## Suction Instruments

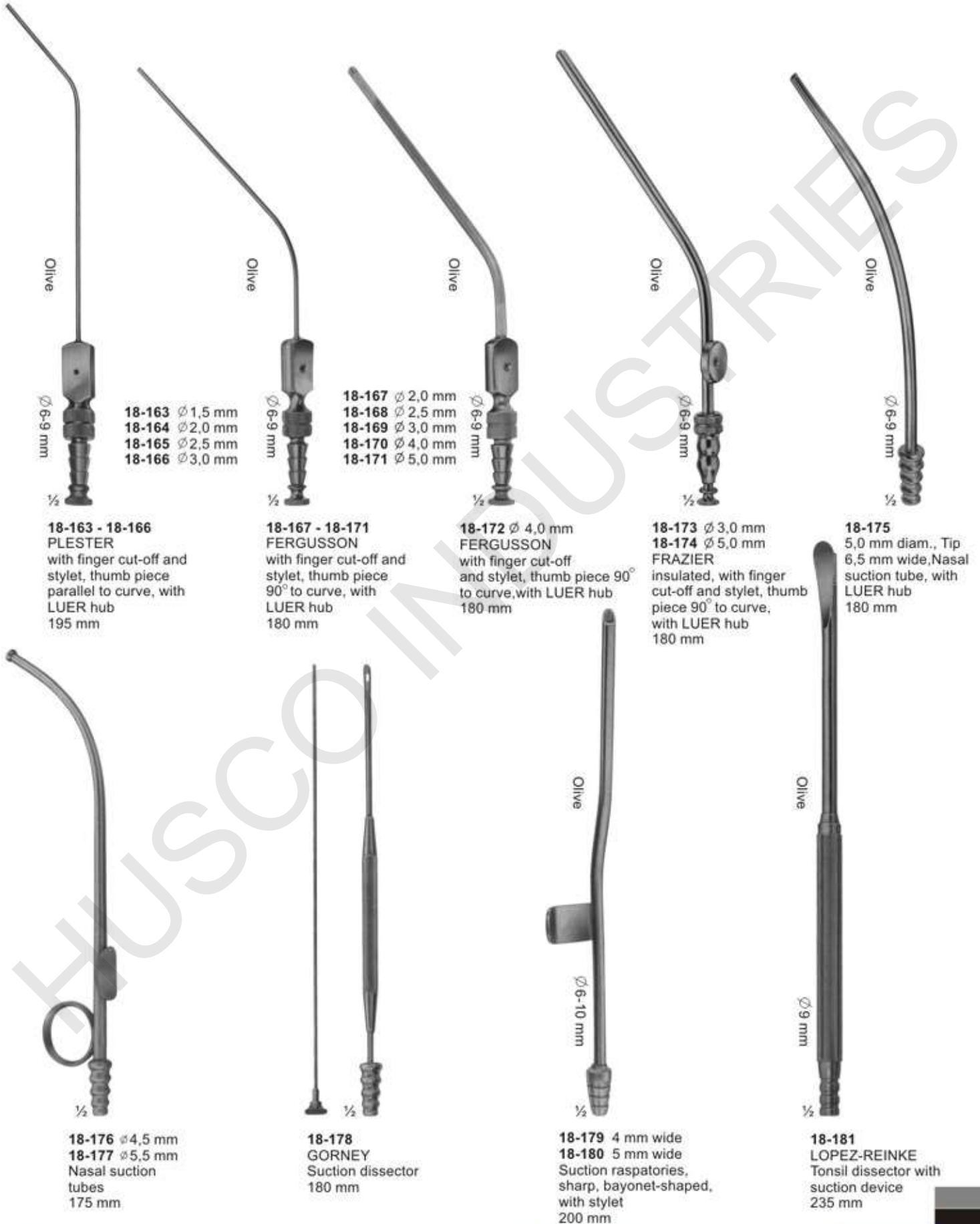

## Dissection Instruments



### 18-182

- 1- Blow pipe .
- 2- 3 PCS .scalpel.
- 3- Dissecting forcep 13 cm.
- 4- Grooved director with tounge tie 13 cm.
- 5- Triple chain hook.
- 6- Dressing scissors probe pointed 13 cm.
- 7- Probe double 13 cm.
- 8- Zipper case inside red velvet.

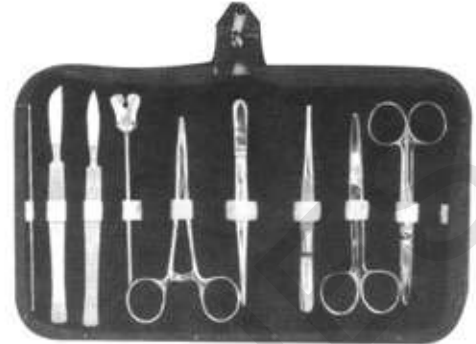

### 18-183

- 1- Probe Double 13 cm
- 2- 2 PCS. Scalpel S.S
- 3- Grooved Director With tongue Tie 13 cm
- 4- Mayo Hegar Needle Holder 13cm
- 5- Disscting Forcep 13 cm 1x2 Teeth
- 6- Dressing Forcep 13 CMS Serrated.
- 7- Dressing Scissor 13 cm S/B STR.
- 8- Dressing Scissor 13 cm S/B CVD.
- 9- Zipper Case Inside Red Velvet.

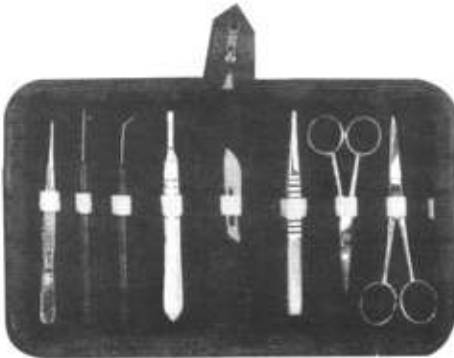

### 18-184

- 1- Dissecting Forcep 11.5 cm Sharp Point.
- 2- Iris Scissor
- 3- B.P Handle No. 4
- 4- Teasing Needle Sharp angular.
- 5- Blade No. 22
- 6- Thumb Forceps T.O.E 13 cm
- 7- Dissecting Scissor STR 11.5 cm
- 8- Dissecting Scissor STR 13 cm
- 9- Zipper case Inside Red Velvet

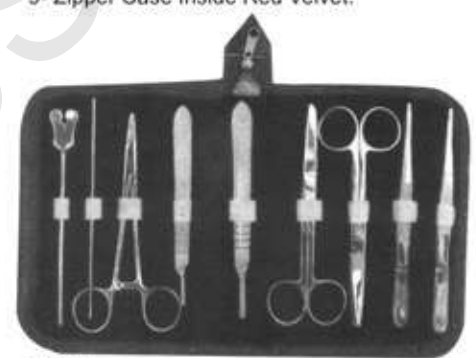

### 18-185

- 1- Grooved Director with Tongue Tie 14 cm
- 2- Probe Double 14cm
- 3- Mayo Hegar Needle Holder 14 cm
- 4- BP. Handle no.3
- 5- BP. Handle no.4
- 6- Dressing Scissor 14 cm S/B STR
- 7- Dressing Scissor 14 cm S/B CVD.
- 8- Dressing Forcep 1x2 Teeth 14 cm
- 9- Dressing Forcep Serrated 14 cm

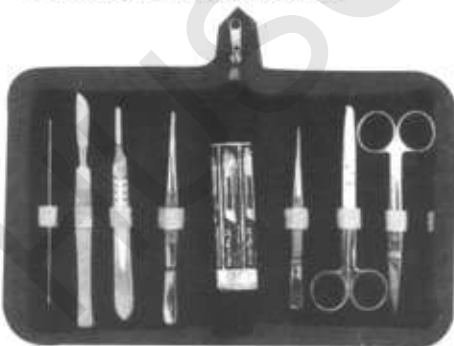

### 18-186

- 1- Probe double 12.5 cm
- 2- Scalpel
- 3- B.P Handle No. 4
- 4- 6 PCS Blade 2 each no. 21, 22, 23
- 5- Dissecting Forcep 12.5 cm
- 6- Dissecting Forcep 11.5 cm sharp Point
- 7- Dissecting Scissor S/B STR 13 cm
- 8- Dissecting Scissor S/S STR 13 cm



### 18-187

- 1- Teasing Needle with Chuck CVD.
- 2- Huber Probe
- 3- Iris Scissor
- 4- Dissecting Forcep Fine 14 cm.
- 5- Dissecting Forcep Fine CVD. 12 cm
- 6- Operating Scissor with Probe 14 cm.
- 7- B.P. Handle no. 4

## Dissection Instruments



### 18-188

- 1- Probe with eye
- 2- Dissecting Forcep cvd fine 12 cm.
- 3- Iris Scissor
- 4- Operating Scissor S/B str 14 cm
- 5- Grooved Director and Tongue tie
- 6- Huber Probe
- 7- Triple Chain Hook
- 8- B.P Handle No. 4
- 9- B.P Handle No. 3
- 10- Teasing Needle with Chuck cvd.
- 11- Teasing Needle with Chuck str.
- 12- Dissecting Forceps Fine 14 cm.

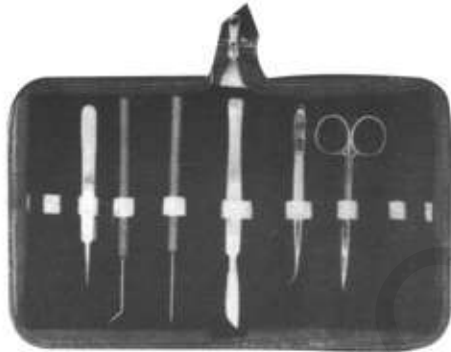

### 18-190

- 1- Iris Scissor STR
- 2- Dissecting Forceps CVD 12 cm.
- 3- Scalpel
- 4- Teasing Needle STR wooden handle.
- 5- Teasing Needle CVD wooden handle.
- 6- Watchmaker fine point.



### 18-192

- 1- Probe double end.
- 2- Grooved director and tongue tie.
- 3- B.P handle no.4
- 4- Operating scissor STR S/b14cm.
- 5- Kelly forceps STR 14cm.
- 6- Dissecting forceps thumb 13cm.

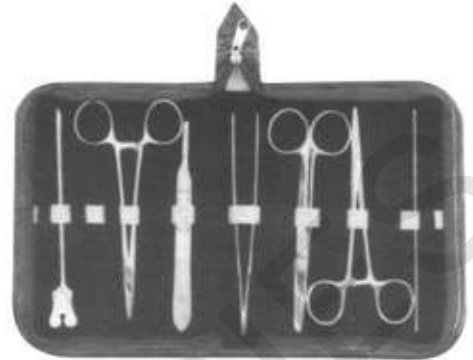

### 18-189

- 1- Grooved Director and Tongue tie
- 2- Mayo Hearn Needle Holder 14 cm
- 3- B.P Handle No. 4
- 4- Dissecting Forceps Thumb 14 cm.
- 5- Operating Scissor S/B str 14 cm
- 6- Kelly Forcep STR 14 cm.
- 7- Probe Double end



### 18-191

- 1- Probe Double end
- 2- B.P Handle No. 4
- 3- Dissecting Forcep 1x2 Teeth 14 cm.
- 4- Operating Scissor S/B str 14 cm
- 5- Mayo Hearn Needle Holder 14 cm
- 6- Kelly Forcep STR 14 cm.
- 7- Operating Scissor S/B CVD 14 cm
- 8- Grooved Director and Tongue tie
- 9- Dissecting Forceps Thumb 14 cm.

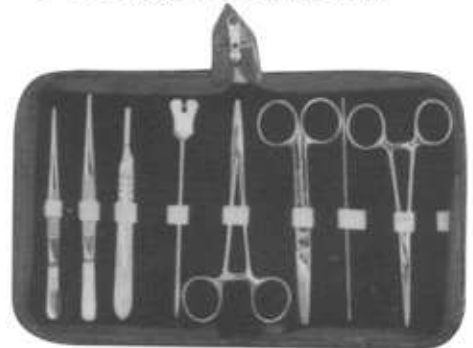

### 18-193

- 1- Dissecting Forceps Thumb 14 cm
- 2- Dissecting Forcep 1x2 Teeth 14 cm.
- 3- B.P Handle No. 3
- 4- Grooved Director and Tongue tie
- 5- Mayo Hearn Needle Holder 14 cm
- 6- Operating Scissor S/B str 14 cm
- 7- Probe Double end
- 8- Kelly Forcep STR 14 cm.



## Dissection Instruments



### 18-194

- 1- Dissecting Forcep Fine 14cm.
- 2- Dissecting Forcep Fine CVD 12cm
- 3- Dissecting Forcep with Pin 14cm.
- 4- Watchmaker Fine point
- 5- Iris scissor STR
- 6- Iris scissor CVD.
- 7- Teasing Needle holder
- 8- Teasing Needle STR.
- 9- B.P. Handle no. 3



### 18-195

- 1- Teasing Needle STR.
- 2- Grooved Director and Tongue Tie.
- 3- Teasing Needle CVD.
- 4- Dissecting Forcep with Pin 12 cm Fine
- 5- Operating Scissor S/B STR 14 cm
- 6- Triple Chain Hook
- 7- Probe with eye
- 8- Probe Double end
- 9- Probe and Hook
- 10- Dissecting Forcep Fine 14 cm
- 11- Iris Scissor
- 12- Huber Probe
- 13- B.P. Handle no.3
- 14- B.P. Handle no.4



### 18-196

- 1- Dissecting forcep fine STR with pin 12cm.
- 2- Iris scissor STR.
- 3- Probe with eye.
- 4- Probe and hook.
- 5- Operating scissor S/B STR 14cm
- 6- Triple chain hook.
- 7- B.P. handle no.4
- 8- Humber probe.
- 9- B.P.handle no.3
- 10- Teasing needle STR plastic handle.
- 11- Teasing needle CVD plastic handle.
- 12- Grooved director and tongue tie.
- 13- Probe double end.



### 18-197

- 1- Dissecting Forceps Thumb 14 cm.
- 2- Dissecting Forcep 1x2 Teeth 14 cm.
- 3- B.P Handle No. 3
- 4- Grooved Director and Tongue tie
- 5- Mayo Hearn Needle Holder 14 cm
- 6- Operating Scissor S/B str 14 cm
- 7- Probe Double end
- 7- Kelly Forcep STR 14 cm.

## Hospital Wares



**19-101 - 115**  
Schimmelbusch

|               | Ø x H<br>sizes in mm |
|---------------|----------------------|
| <b>19-101</b> | 80 x 80              |
| <b>19-102</b> | 105 x 120            |
| <b>19-103</b> | 140 x 140            |
| <b>19-104</b> | 160 x 120            |
| <b>19-105</b> | 160 x 150            |
| <b>19-106</b> | 190 x 150            |
| <b>19-107</b> | 190 x 190            |
| <b>19-108</b> | 240 x 160            |
| <b>19-109</b> | 240 x 240            |
| <b>19-110</b> | 290 x 160            |
| <b>19-111</b> | 290 x 240            |
| <b>19-112</b> | 340 x 160            |
| <b>19-113</b> | 340 x 340            |
| <b>19-114</b> | 390 x 190            |
| <b>19-115</b> | 390 x 290            |



**19-116**  
Box  
120 x 65 x 13mm  
(without Bulldog clamps,  
without silicone tape)



**19-117**  
Box with support  
120 x 65 x 13 mm  
(ohne Bulldogklemmen)



**19-118**  
Box with support for  
needle electrodes,  
without instruments



**19-119 - 121**  
50 x 25 x 4,5 mm  
**19-120**  
65 x 42 x 8 mm  
**19-121**  
75 x 25 x 4,5 mm



**19-122**  
Ø 65mm x 15mm

# Hospital Wares



19-123 - 131

|        | Ø x H        |
|--------|--------------|
| 19-123 | 30 x 90 mm   |
| 19-124 | 50 x 100 mm  |
| 19-125 | 50 x 130 mm  |
| 19-126 | 50 x 175 mm  |
| 19-127 | 75 x 100 mm  |
| 19-128 | 75 x 130 mm  |
| 19-129 | 75 x 175 mm  |
| 19-130 | 100 x 175 mm |
| 19-131 | 100 x 200 mm |



19-141 - 142

- 19-141** Martin Sterilizing Forceps consisting of:  
1 Sterilizing Forceps, curved, 25 cm, without ratchet, with lid for jar  
1 jar with bottom plate (anti-tilt)
- 19-142** ditto, with 32 cm long Sterilizing Forceps



19-132 - 139

|        |                   |
|--------|-------------------|
| 19-132 | 165 x 85 x 35 mm  |
| 19-133 | 200 x 100 x 35 mm |
| 19-134 | 200 x 100 x 50 mm |
| 19-135 | 230 x 130 x 50 mm |
| 19-136 | 260 x 150 x 50 mm |
| 19-137 | 270 x 235 x 50 mm |
| 19-138 | 300 x 200 x 50 mm |
| 19-139 | 325 x 275 x 50 mm |



**19-140**  
205 x 105 x 35 mm

## Round Metal Boxes and Medicine Cups



19-143 - 148

|         | Ø x H        |
|---------|--------------|
| 19-143  | 75 x 60 mm   |
| 19-144  | 75 x 75 mm   |
| 19-145  | 100 x 60 mm  |
| 19-146  | 100 x 100 mm |
| 19-146A | 125 x 80 mm  |
| 19-147  | 125 x 125 mm |
| 19-148  | 150 x 150 mm |



19-149  
25 cc

19-150  
50 cc



19-151  
20 cc  
Medicine Spoon



19-152  
Ø 75 x 12 mm  
Tablet Tray



19-153  
Ø 90 x 90 mm  
Metal Cup



19-154  
Ø 75 x 80 mm  
Sputum Cup



Kidney Dish



19-155 - 157

|        |                   |
|--------|-------------------|
| 19-155 | 170 x 100 x 35 mm |
| 19-156 | 250 x 140 x 40 mm |
| 19-157 | 275 x 150 x 45 mm |

## Hospital Wares



19-158 - 165

|        | Ø x H       |       |  |
|--------|-------------|-------|--|
| 19-158 | 40 x 19 mm  | 0.05L |  |
| 19-159 | 61 x 30 mm  | 0.07L |  |
| 19-160 | 80 x 40 mm  | 0.14L |  |
| 19-161 | 116 x 50 mm | 0.35L |  |
| 19-162 | 128 x 55 mm | 0.45L |  |
| 19-163 | 147 x 65 mm | 0.70L |  |
| 19-164 | 167 x 75 mm | 1.10L |  |
| 19-165 | 187 x 85 mm | 1.60L |  |



19-166 - 170

|        |             |       |
|--------|-------------|-------|
| 19-166 | 116 x 35 mm | 0.30L |
| 19-167 | 128 x 38 mm | 0.40L |
| 19-168 | 147 x 40 mm | 0.50L |
| 19-169 | 157 x 45 mm | 0.75L |
| 19-170 | 187 x 45 mm | 1.00L |



19-171  
Ø 110 x 28 mm 0.15L



19-172  
100 cc 0.1L



19-173 - 176  
19-173 0,25L  
19-174 0,50L  
19-175 1,00L  
19-176 2,00L



19-177  
235 x 190 x 40 mm



19-178  
Ø 220 x 70 mm

**Hospital Wares**



**19-179**  
 Ø 50 x 100 mm  
 Powder Pot



**19-180**  
 Ø 50 x 75 mm  
 Methot With Lid



**19-181**  
 Ø 50 x 75 mm  
 Methot Without Lid



**19-182**



**19-183**



**19-184**



**19-185 - 186**

**19-185** Ø 235 mm  
**19-186** Ø 310 mm

## Needle Cases



**19-187**  
Sauerbruch  
210 x 125 x 17 mm



**19-188**  
Sauerbruch  
210 x 125 x 17 mm



**19-189**  
150 x 95 x 13 mm



**19-190**  
150 x 95 x 13 mm



**19-191**  
150 x 95 x 13 mm



**19-192**  
150 x 95 x 13 mm



**19-193**  
150 x 95 x 13 mm



**19-194**  
150 x 95 x 13 mm



**19-195**  
150 x 95 x 11 mm

## Storing Cases



19-199 - 209

|        |                |    |
|--------|----------------|----|
| 19-199 | 230 x 130 x 50 | mm |
| 19-200 | 260 x 150 x 50 | mm |
| 19-201 | 275 x 235 x 50 | mm |
| 19-202 | 300 x 200 x 50 | mm |
| 19-203 | 325 x 275 x 50 | mm |
| 19-204 | 420 x 175 x 50 | mm |
| 19-205 | 230 x 130 x 75 | mm |
| 19-206 | 260 x 150 x 75 | mm |
| 19-207 | 300 x 200 x 75 | mm |
| 19-208 | 325 x 275 x 75 | mm |
| 19-209 | 420 x 175 x 75 | mm |



**19-196**  
Deponette  
245 x 135 x 35mm



**19-197**  
Deponette  
245 x 135 x 50mm



**19-198**  
Deponette  
245 x 135 x 60mm



## Sterilizing Baskets / Trays



19-210 - 212

|        |                 |    |
|--------|-----------------|----|
| 19-210 | 480 x 250 x 50  | mm |
| 19-211 | 520 x 250 x 75  | mm |
| 19-212 | 520 x 250 x 100 | mm |

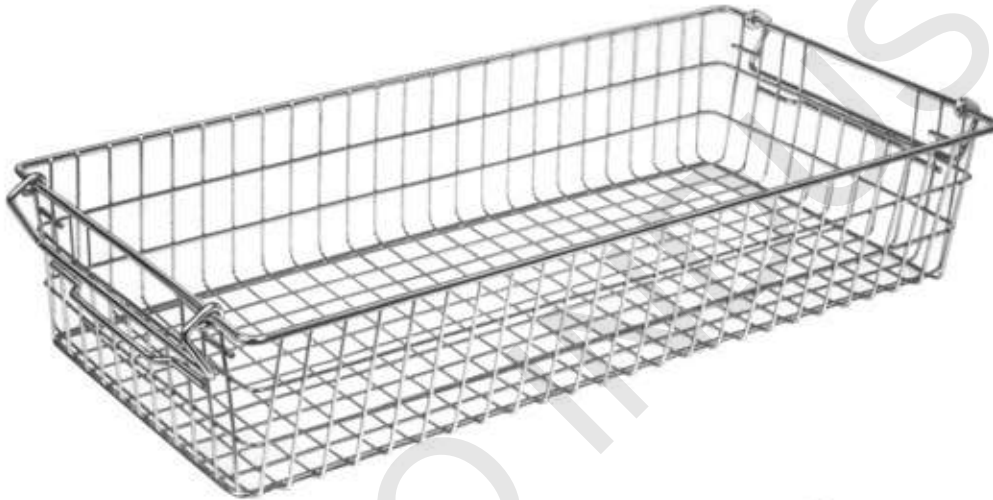

19-219  
(60 x 30 x 15 cm)  
Nominal dimensions.



19-213 - 218

|        |                 |    |
|--------|-----------------|----|
| 19-213 | 240 x 240 x 50  | mm |
| 19-214 | 240 x 240 x 80  | mm |
| 19-215 | 240 x 240 x 100 | mm |
| 19-216 | 480 x 260 x 50  | mm |
| 19-217 | 520 x 260 x 80  | mm |
| 19-218 | 520 x 260 x 100 | mm |

## Scissors with Tungsten Carbide Inserts

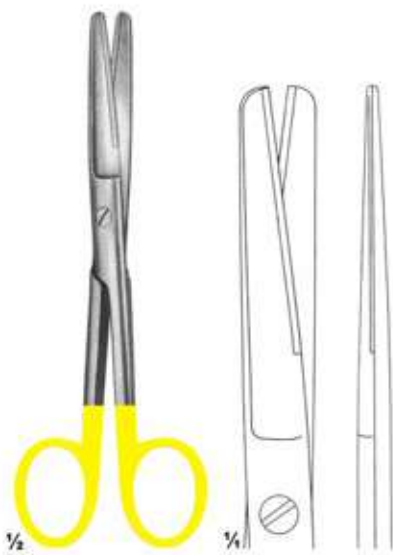

**26-101**  
Standard

14,5cm  
16,5cm  
18,5cm



**26-102**  
Standard

14,5cm  
16,5cm  
18,5cm



**26-103**  
Standard

14,5cm  
16,5cm  
18,5cm



**26-104**  
Standard

14,5cm  
16,5cm  
18,5cm



**26-105**  
Standard

14,5cm  
16,5cm  
18,5cm



**26-106**  
Standard

14,5cm  
16,5cm  
18,5cm

## Scissors with Tungsten Carbide Inserts

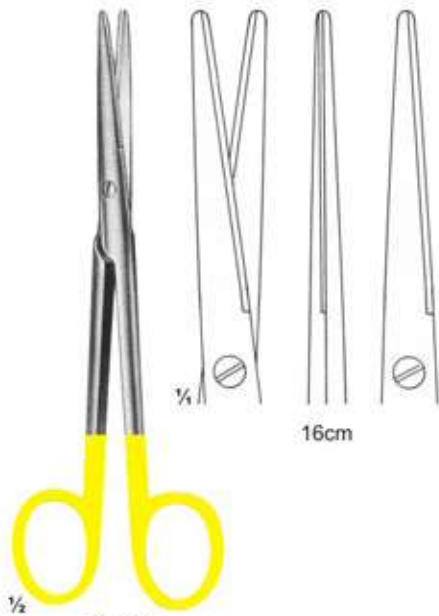

26-107  
Mayo-Lexer

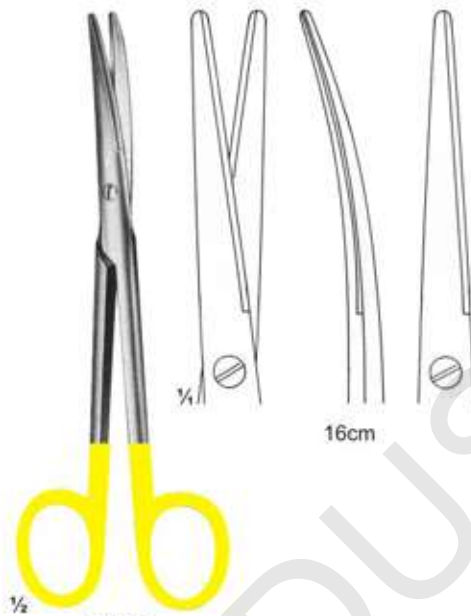

26-108  
Mayo-Lexer



26-109  
Lexer



26-110  
Lexer

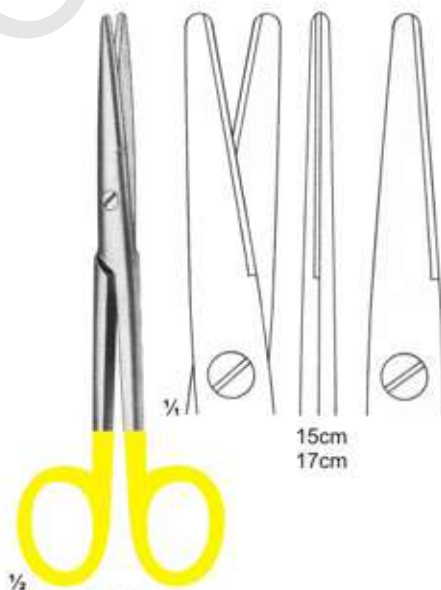

26-111  
Mayo-Stille

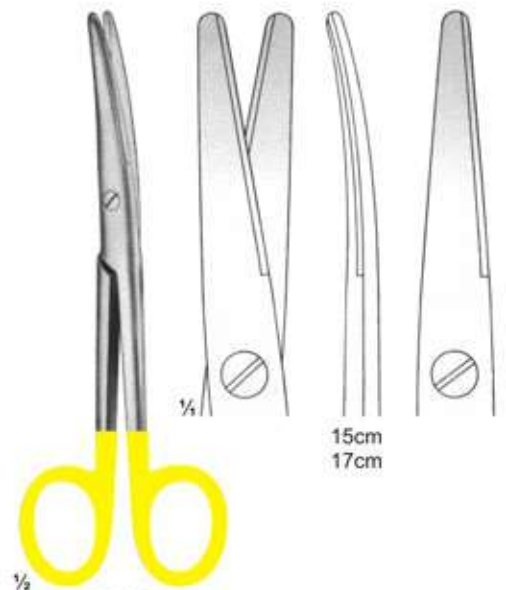

26-112  
Mayo-Stille

## Scissors with Tungsten Carbide Inserts

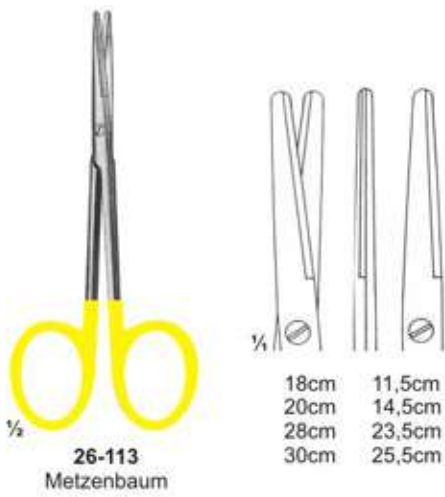

## Scissors with Tungsten Carbide Inserts

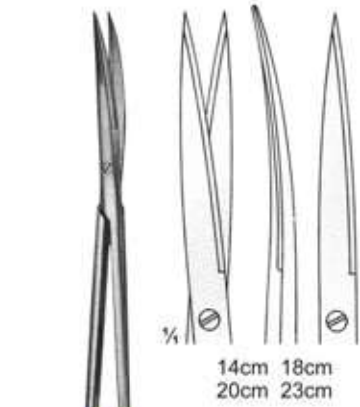

1/2  
**26-119**  
 Metzenbaum-Fino

14cm 18cm  
 20cm 23cm

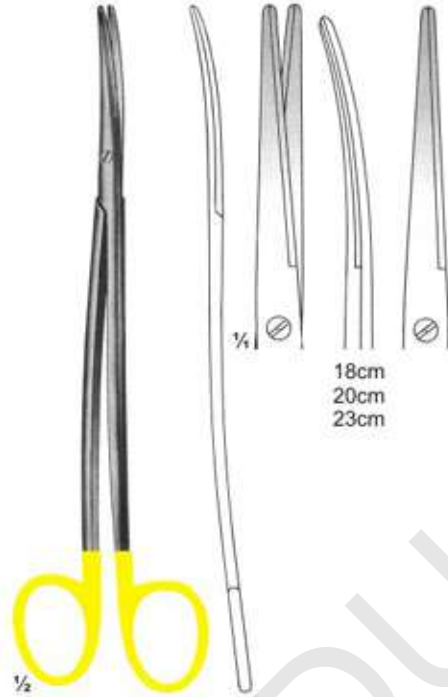

1/2  
**26-120**  
 Metzenbaum-Fino

18cm  
 20cm  
 23cm



1/2  
**26-121**  
 Metzenbaum-Fino

18cm  
 20cm  
 23cm



1/2  
**26-122**  
 Metzenbaum

20cm  
 23cm



1/2  
**26-123**  
 Mayo

14,5cm  
 17cm  
 23cm

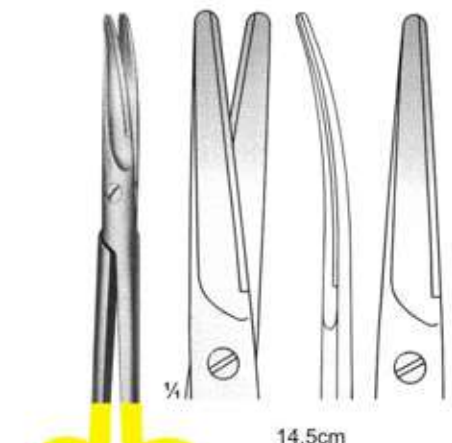

1/2  
**26-124**  
 Mayo

14,5cm  
 17cm  
 23cm

## Scissors with Tungsten Carbide Inserts

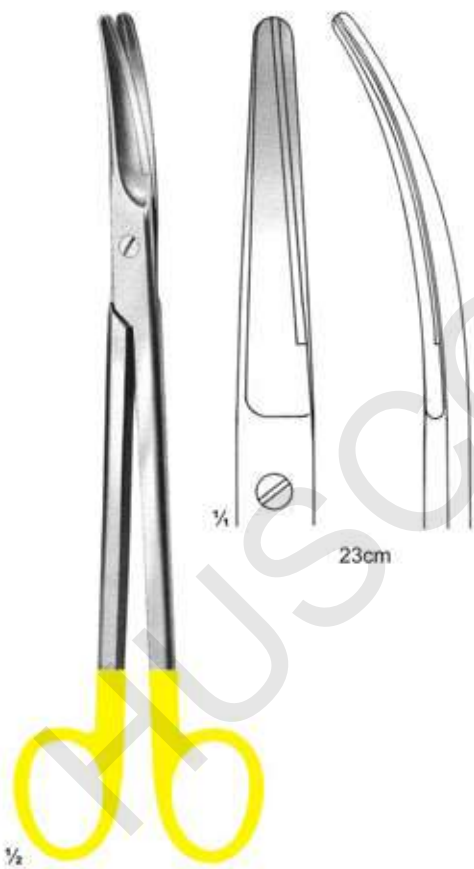

**26-125**  
Parametrium

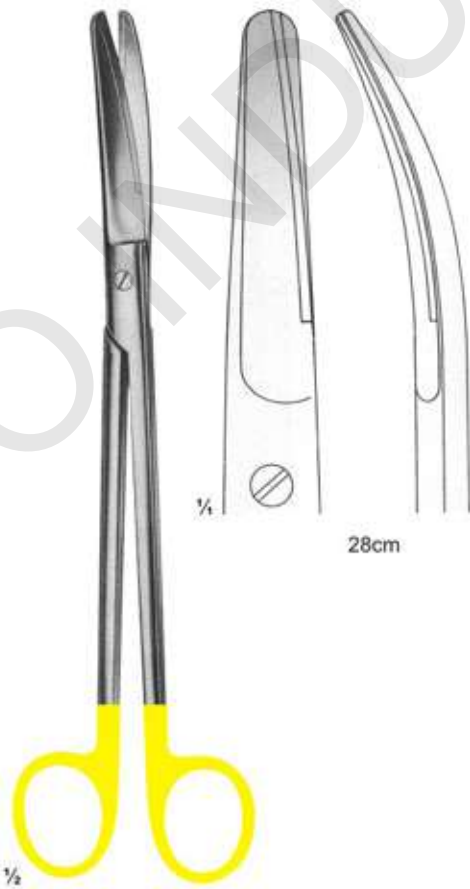

**26-126**  
Mayo-Harrington

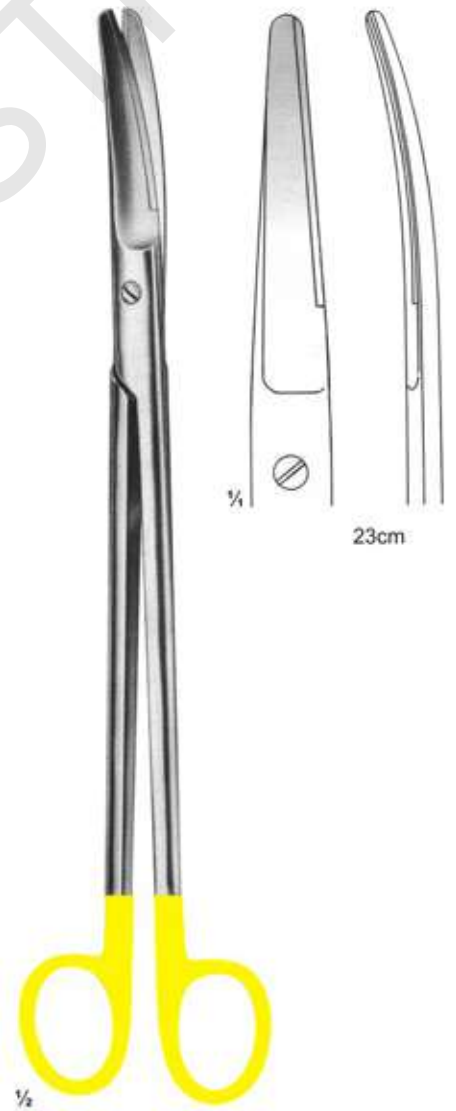

**26-127**  
Sims

## Scissors with Tungsten Carbide Inserts

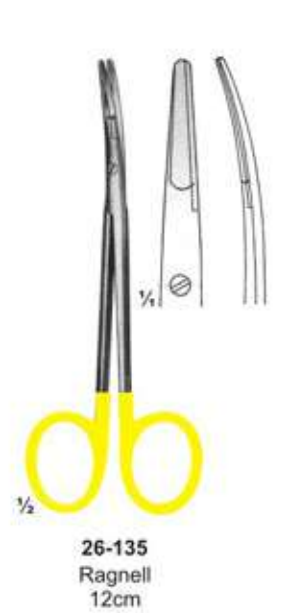
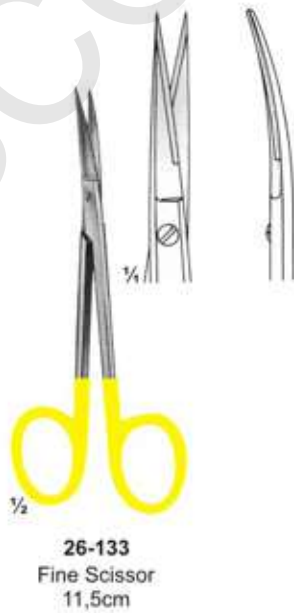
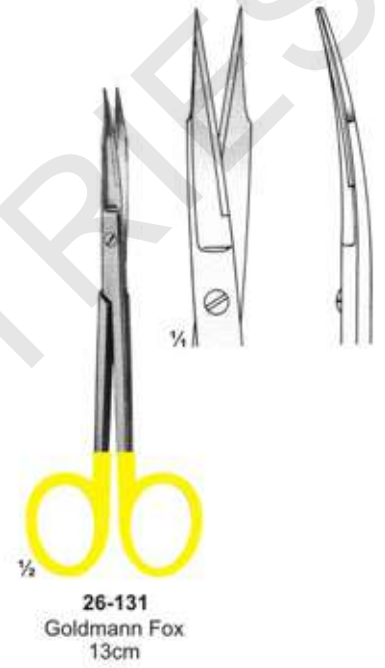

# Scissors & Dissecting Forceps with Tungsten Carbide Inserts

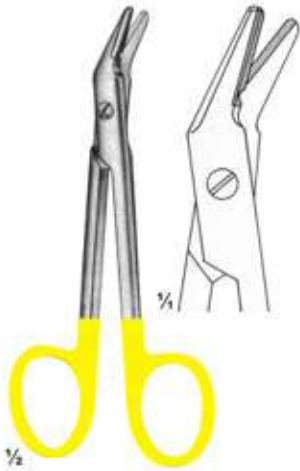

**26-136**  
Universal  
12cm



**26-137**  
Ligature Scissors  
1 Black & 1 Goldplated ring



**26-138**  
Adson



**26-139**  
Cushing  
17,5cm



**26-140**  
Cushing  
18cm



**26-141**  
Cushing-Taylor  
18cm



**26-142**  
Dissecting Forceps  
15cm



**26-143**  
Semken  
15cm



## Dissecting Forceps and Needle holders with

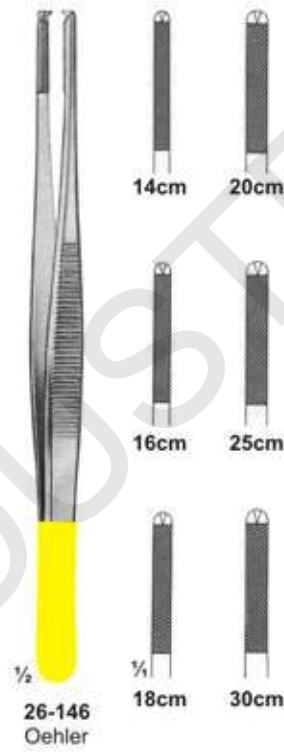
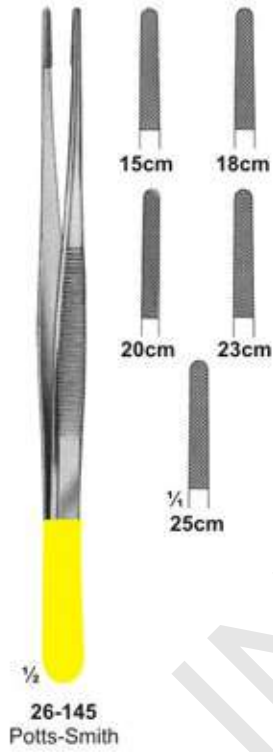

## Needle holders with Tungsten Carbide Inserts



**26-152**  
Arruga  
16cm



**26-153**  
Castroviejo  
13cm



**26-154**  
Hegar  
20cm 24cm

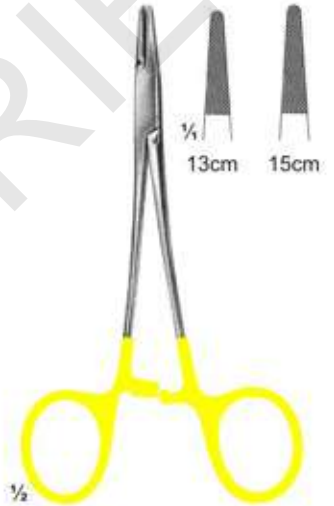

**26-155**  
Halsey  
13cm 15cm



**26-156**  
Mayo-Hegar  
16cm 18cm 20cm  
24cm 26cm 30cm



**26-157**  
De-Bakey  
18cm 20cm 23cm  
26cm 31cm 37cm

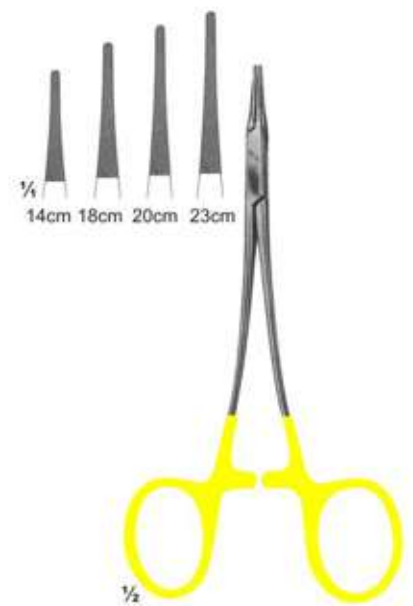

**26-158**  
Hegar-Vascular  
14cm 18cm  
20cm 23cm

## Needle holders with Tungsten Carbide Inserts



1/2  
**26-159**  
Bozemann-Wertheim  
20cm 24cm 26cm



1/2  
**26-160**  
Stratte  
22cm 23cm

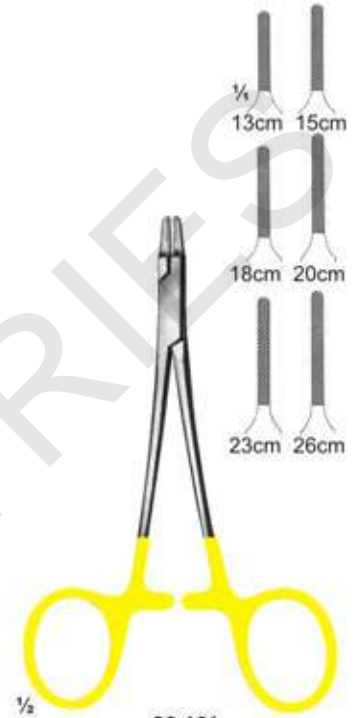

1/2  
**26-161**  
Ryder  
13cm 15cm 18cm  
20cm 23cm 26cm



1/2  
**26-162**  
Ryder-Vascular  
13cm 15cm 18cm  
20cm 23cm 26cm



1/2  
**26-163**  
Martin  
15cm 17cm 20cm



1/2  
**26-164**  
Sarot  
18cm 20cm 26cm

## Needle holders with Tungsten Carbide Inserts



## Needle holders with Tungsten Carbide Inserts



**26-172**  
Mathieu-Ryder  
17cm  
20cm 24cm



**26-173**  
Lichtenberg  
20cm



**26-174**  
Langhals  
20cm 25cm



**26-175**  
Lichtenberg  
20cm 25cm



**26-176**  
Luehty-Beck  
20cm 25cm



**26-177**  
Luehty-Beck  
20cm 25cm



**26-178**  
Langebeck  
18cm  
20cm 23cm

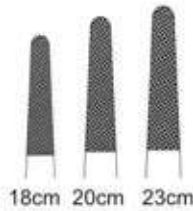

**26-179**  
Langebeck-beck  
18cm  
20cm 23cm

**Wire Cutting Plier With T.C. Inserts**



**26-180**  
**TOENNIS**  
 Elastic pattern for  
 dura-or intestinal suture  
 180 mm

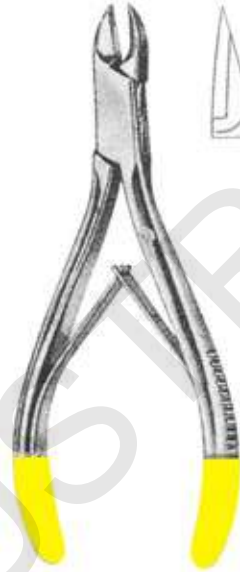

**26-181**  
 Cutting Plier  
 12 cm

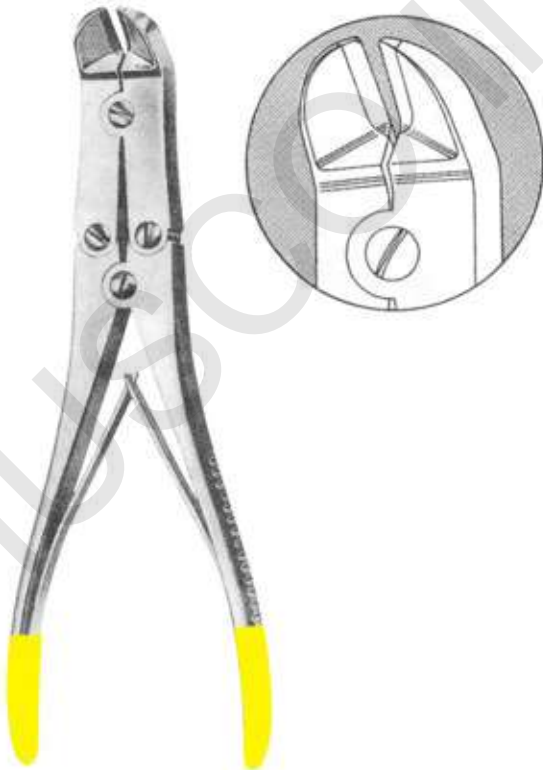

**26-182**  
**MULLAR CLAUS**  
 22 cm



**26-183**  
 Plier  
 17.5 cm



## Surgical instruments

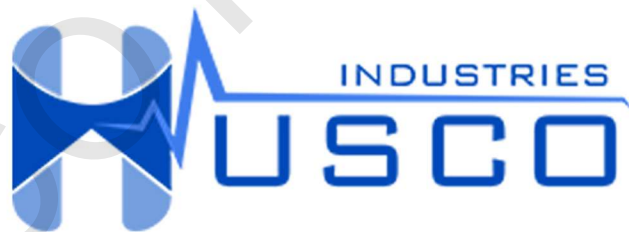

### **HUSCO INDUSTRIES**

Address: Small industrial estate, Street 316 C,  
Fatehgarh, near abrona group Sialkot 51310 - PAKISTAN

MOBILE / WHATSAPP : +923496025355

EMAIL: [huscoindustries@gmail.com](mailto:huscoindustries@gmail.com)  
[info@huscoind.com](mailto:info@huscoind.com)